



FLORIDA FISH AND WILDLIFE CONSERVATION COMMISSION

MARINE TURTLE CONSERVATION GUIDELINES

November 2007

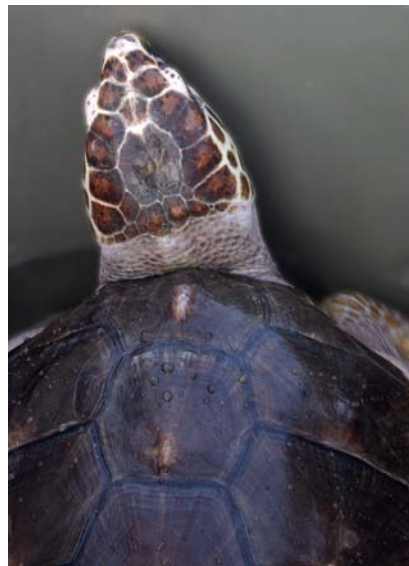

TABLE OF CONTENTS

	PAGE
Section 1 - GENERAL INFORMATION FOR PERMIT HOLDERS	
Turtle Program Organizational Chart	1-1
General Permit Information	1-2
Guidelines	1-2
Reporting Requirements (overview).....	1-3
Training.....	1-3
Monitoring for Coastal Construction Projects	1-3
Section 2 - NESTING BEACH SURVEY ACTIVITIES	
Statewide and Index Nesting Beach Surveys.....	2-1
Species Identification and Determination of Nesting Success	2-3
Nest Marking	2-9
Hatching Success Evaluations (Nest Inventories)	2-12
Reporting Requirements.....	2-15
Hatchling Rescue and Release.....	2-17
Hatchling and Adult Disorientation.....	2-18
Predator Control.....	2-19
Nest Screening	2-21
Nest Caging.....	2-23
Nest Relocation.....	2-26
Section 3 - STRANDING AND SALVAGE ACTIVITIES	
Stranding and Salvage.....	3-1
Completing the STSSN Data Report Sheet	3-3
Live Turtle Transport.....	3-5
Conducting Necropsies	3-6
Reporting Requirements	3-6
TED Turtles	3-6
Section 4 – HOLDING MARINE TURTLES IN CAPTIVITY	
Holding Turtles for Education	4-1
Holding Non-Releasable Turtles.....	4-2
Holding Turtles for Rehabilitation.....	4-3
Holding Turtles for Research.....	4-3
Holding Tank Requirements	4-4
Water Quality and Feeding Standards	4-6
Veterinary Care.....	4-7
Transporting Live Turtles	4-7
Release of Rehabilitated Turtles	4-8
Necropsy Requirements for Turtles that Die in Captivity	4-9
Disposition of Dead Turtles	4-10
Facility Inspections	4-10
Quarterly and Annual Reporting Requirements	4-10
Educational Presentations Using Live Marine Turtles	4-12
Dive/Snorkel Programs In Tanks Holding Marine Turtles.....	4-13

Section 5 - TAGGING MARINE TURTLES	
Handling and Flipper Tagging Turtles.....	5-1
Measuring Marine Turtles.....	5-2
PIT Tagging	5-3
Section 6 - RESEARCH ACTIVITIES	
New Research Projects	6-1
Amendments to Approved Projects	6-2
Reporting Requirements	6-2
Section 7 - EDUCATIONAL ACTIVITIES	
Public Awareness Turtle Watches	7-1
Nighttime Public Hatchling Releases	7-4
Maintain and Display Preserved Specimens.....	7-6
Appendix A – FORMS, ETC.	
Marine Turtle Monitoring for Beach Restoration Projects.....	A-1
Marine Turtle Holding Facility Quarterly Report.....	A-2
Educational Presentation Using Live Turtles Form.....	A-6
Disorientation Incident Report.....	A-7
Marine Turtle Necropsy Report	A-8
FWC Nighttime Public Hatchling Release form	A-10
Fibropapilloma Documentation Form.....	A-11
FWC Public Turtle Watch Schedule.....	A-12
FWC Public Turtle Watch Summary.....	A-13
Sea Turtle Stranding and Salvage Network Stranding Report.....	A-14
Tagging Data Form.....	A-16
FWC Marine Turtle Transfer Form	A-17
Appendix B - GLOSSARY OF TERMS	B
Appendix C - RESOURCES	
List of Local Government Lighting Ordinances.....	C-1
Nest Signs	C-6
Educational Web Site Links.....	C-7
Bumper Stickers and other Educational Brochures	C-9
Selected References	C-12
License Plate Information	C-13
Decal Information	C-13
Appendix D – QUICK REFERENCE TABLES	
Table D-1. Authorized Activities.....	D-1
Table D-2. Reporting Requirements	D-3
Table D-3. Why’s and How’s of Nest Protection and Marking	D-4
Table D-4. Conducting Nesting Surveys and Related Activities.....	D-5

MARINE TURTLE PROGRAM ORGANIZATIONAL CHART
(Current as of 2007)

FLORIDA FISH AND WILDLIFE CONSERVATION COMMISSION
Executive Director's Office

Division of Fish and Wildlife Research Institute (FWRI)
Director

Wildlife Research Section
Section Leader

FWRI Marine Turtle Program Staff:

St. Petersburg Office – (727) 896-8626

Sr. Research Scientist – Statewide Nesting Beach Survey program coordinator

Biological Scientist II – assists with compilation of SNBS & INBS data and staff research

Wildlife Technician – assists with west coast stranding activity and staff research

Wildlife Technician – coordinates in-water research statewide

Administrative Assistant

Jacksonville Field Office – (904) 573-3930
Assistant Research Scientist – coordinates Florida Stranding and Salvage Network

Melbourne Beach Field Office -- (321) 674-1801
Associate Research Scientist – coordinates Index Nesting Beach Survey (INBS)

Research Staff – assists with staff research

Tequesta Field Office – (561) 575-5407
Wildlife Technician – assists with east coast stranding activity and staff research

Wildlife Technician – assists with east coast stranding activity and staff research

Tallahassee Office – (850) 922-4330

Division of Habitat and Species Conservation (HSC)

Imperiled Species Management Section (ISM)
Section Leader

ISM Marine Turtle Program Staff:

Tallahassee Office – (850) 922-4330

Biological Administrator III – supervises ISM Marine Turtle Program staff

Environmental Specialist II – reviews coastal construction project permit applications for marine turtle impacts

Environmental Specialist II – assists with review of coastal construction project permit applications for marine turtle impacts

Environmental Specialist I – assists with review of coastal construction project permit applications for marine turtle impacts

Environmental Specialist I – assists with review of coastal construction project permit applications for marine turtle impacts

Administrative Assistant

Tequesta Field Office – (561) 575-5407

Environmental Specialist II (ISM) – coordinates review & processing of marine turtle permits, tracks captive facility activity

Environmental Specialist (ISM) – coordinates coastal lighting issues statewide

SECTION 1 – GENERAL INFORMATION FOR PERMIT HOLDERS

GENERAL PERMIT INFORMATION

The Fish and Wildlife Conservation Commission (FWC) issues permits for activities involving marine turtles in Florida under authority granted to the state through a Cooperative Agreement with the U.S. Fish and Wildlife Service (USFWS) under Section 6 of the U.S. Endangered Species Act (ESA). All activities relating to marine turtles must be authorized under subsection 370.10 (1), Florida Statutes. To qualify for a marine turtle permit, the applicant must have the appropriate knowledge and experience and demonstrate that the proposed activity adds to the conservation of marine turtles.

Each permit consists of a principal permit holder, authorized personnel, and a list of authorized activities, construction monitoring projects and research projects. Every permit holder is authorized to conduct specific activities depending upon their experience, the area of investigation, and demonstrated marine turtle conservation needs. Only those activities and projects specifically listed on the permit are authorized. The permit holder is expected to know the conditions and responsibilities associated with their permit and to work according to these guidelines.

All authorized personnel should carry a copy of their FWC permit at all times while conducting authorized activities. You should also carry identification that will verify that you are the permit holder or one of the authorized personnel. Wildlife or public safety officers may approach you, in plain clothes, and ask to see a copy of your permit. You may also be approached by concerned individuals who perceive that your activity is harmful or unlawful. Please ensure that your response to such situations is thoughtful and reflects the special responsibilities associated with your permit.

Your permit does not allow you to act as an agent of FWC with powers vested in a public employee. Please do not represent yourself as a wildlife or conservation officer unless you are one. Distinctive identifying clothing is encouraged and should display the logo or name of your organization, not symbols associated with FWC. In other words, avoid the appearance of a uniformed public employee unless you are one.

Marine turtle permits are not transferable. Persons wishing to apply for a permit must submit a FWC Marine Turtle Permit Application. Applications may be obtained by contacting the Imperiled Species Management Section (ISM) at (561) 575-5407. Each application must identify the principal permit holder; up to 24 additional volunteers can be included per permit. If there are more than 24 additional people involved with the permitted activity, FWC can issue more than one permit to a principal permit holder for the activity and individuals involved. However, the principal permit holder is still responsible for training and oversight of all volunteers.

GUIDELINES

These guidelines provide instruction to Florida marine turtle permit holders on acceptable research and conservation techniques. Additional copies of the guidelines can be obtained from FWC or downloaded from the agency web site

<http://www.myfwc.com/seaturtle/Guidelines/MarineTurtleGuidelines.htm>. Permit holders are authorized to conduct only those activities specifically listed on their marine turtle permit.

REPORTING REQUIREMENTS

All activities and research projects (see below for coastal construction monitoring projects) authorized under a marine turtle permit, as well as the results, must be reported on an annual basis to the FWC. The reporting requirements for all activities described in these guidelines are identified at the end of each section. Issuance of subsequent authorizations is contingent upon following appropriate reporting procedures (or satisfying reporting requirements).

TRAINING

Principal permit holders are expected to be proficient in the activity (ies) that they are authorized to conduct. The principal permit holder is responsible for ensuring that all personnel listed on the permit are thoroughly and properly trained to conduct the activities authorized on their permit. Nest survey training requires that the permit holder spend sufficient time with personnel on the beach, identifying crawls. Permit holders must work with inexperienced personnel until they are confident of their ability to distinguish nests from false crawls and to identify the differences in crawl characteristics between species.

FWC turtle staff provides periodic workshops to permitted personnel to ensure that approved conservation practices are well understood and employed. These workshops are generally designed as refresher courses and are not intended as complete training for persons with no prior survey experience. Due to logistics the workshops do not generally offer much, if any, field training. It is imperative that the principal permit holders spend as much time as necessary providing on-the-beach training for personnel to accurately identify crawls.

MONITORING FOR COASTAL CONSTRUCTION PROJECTS

Under existing state law, certain construction activities may occur along or on your survey beach during the marine turtle nesting season. Under subsections 370.12(1) and 161.053, Florida Statutes, the Florida Department of Environmental Protection (DEP) has implemented specific requirements that condition the nature, timing, and sequence of coastal construction activities to protect nesting marine turtles, hatchlings, and their habitat. All such activities require a DEP permit, which must be kept at the site. Coastal construction projects are reviewed by FWC and the appropriate local governing body (ies).

In general, only those activities that have minimal impacts to nesting turtles, their nests, and hatchlings can occur during the nesting season. These types of activities include dune planting, beach cleaning, and special events. Such activities can only occur if a nesting survey has been ongoing since the beginning of the nesting season or 65 days prior to the event, whichever comes later, and all nests in the project area are clearly marked. Standardized conditions in the DEP permit require the person conducting the work/event to coordinate with the marine turtle permit holder for

a given beach. No work is allowed to commence until after completion of the nesting survey each day. Fences, overnight storage of equipment, water drainage from pumps, lights, and heavy equipment are prohibited on the nesting beach unless specifically authorized in the permit document.

If you are approached by a local contractor, individual, or other entity and asked to conduct a nesting survey or relocate nests in conjunction with any coastal construction or recreational activity (e.g., mechanical beach cleaning, beach nourishment, construction of a crossover, dune restoration project, volleyball tournament, beach driving, etc.), please contact the FWC Imperiled Species Management Section (ISM) immediately. **Marine turtle permits issued by FWC do not authorize nest relocation for any coastal construction project unless incidental take and additional authorization for such relocation has been granted by the U.S. Fish and Wildlife Service (USFWS) and the FWC.**

Should you agree to provide marine turtle monitoring services for a project, we recommend that you enter into a written agreement whereby both parties fully understand the services expected of each. Permits for beach restoration activities require a report of marine turtle nesting activity for the project area (Appendix A – Beach Restoration Project Monitoring). Under certain circumstances, another marine turtle permit holder may be authorized to conduct marine turtle nest survey and nest protection activities associated with a construction project even if the project is within your permitted survey area. Generally, the DEP permitted entity will be instructed to contact the permitted marine turtle survey person for that area first, then to work with other permit holders if the original permit holder cannot conduct the work.

Beach nourishment projects, in particular, are reviewed by FWC, DEP, U.S. Army Corps of Engineers, and USFWS. The USFWS may, under the provisions of Section 7 of the ESA, issue incidental take authorization for the project. Permit holders authorized to relocate nests for conservation purposes may be restricted from doing so by a Section 7 Biological Opinion as follows: **marine turtle permits issued by FWC do not authorize nest relocation for any coastal construction project on which a U.S. Fish and Wildlife Service Section 7 Biological Opinion has been logged unless the permittee receives official written agency (FWC) confirmation that the project is being conducted in a manner consistent with the Section 7 Biological Opinion and Section 370.12 and Chapter 120 Florida Statutes.**

ISM is working to involve marine turtle permit holders in the review of beach nourishment permits. Every beach nourishment project requires that the construction entities conduct a pre-construction meeting that includes the FWC and the marine turtle permit holder.

SECTION 2 - NESTING BEACH SURVEY ACTIVITIES

STATEWIDE AND INDEX NESTING BEACH SURVEYS

Florida's sea turtle nesting surveys take place within two complementary programs: the Statewide Nesting Beach Survey program (SNBS) and the Index Nesting Beach Survey program (INBS). Each is performed by a network of people who receive training and guidance from the FWC's Sea Turtle Protection Program, although surveyors may work principally within conservation organizations, state or local governments, universities, state parks, federal agencies, and private consulting groups. SNBS and INBS surveys have different goals; because of this, each differs somewhat in approach. The resources of the SNBS program are directed toward maximizing the temporal and geographic surveillance of nesting activities on the state's beaches. One product of SNBS is a minimum total count of nests statewide for each species. For management purposes, the broad coverage provides data on which to base management decisions that are needed at the local level throughout the state such as the timing of coastal construction activities. A limitation of the SNBS program is that effort varies among years and among beaches as new survey areas are added. There is also variation in survey frequency, with some remote areas being covered only infrequently. The resources of the INBS program are directed more toward survey consistency and detail. A goal of this program is to use an identical protocol to gather detailed nesting information in a way that allows the assessment of trends over time and between index beach zones. All INBS beaches are also SNBS beaches. A limitation of the INBS program is that only part of the state's beaches and only part of the complete nesting season are surveyed this way. Elements common to both programs include training, methods of nest and track identification, and attempts to make as accurate an assessment of nesting as is possible.

Summary

If your permit authorizes you to **conduct nesting surveys** you are also authorized to conduct the following activities:

- **mark nests**
- **conduct hatching success evaluations**
- **rescue and release hatchlings**

Unless specifically stated on the permit personnel are NOT authorized to conduct the following activities:

- **relocate nests**
- **screen nests with self-releasing screens/cages**
- **screen nests with restraining cages**
- **use a self releasing hatchery**
- **use a restraining hatchery**
- **use probes (other than fingers) to locate clutches**
- **conduct nighttime surveys**
- **conduct public hatchling releases**

Activity Description

This activity involves the daily survey of a specific beach area (as specified on the permit) to identify, enumerate, and evaluate nesting activities. In nesting surveys, surveyors count and identify “crawls,” which are the marks left in the sand by sea turtles that have attempted to nest. The official sea turtle nesting season varies across the state due to geographic differences in the seasonality among the various sea turtle species. For most of the state, nesting season is between May 1, when loggerheads begin nesting, and October 31, after which period most nests of each species have hatched. In Brevard through Broward Counties, where the majority of leatherback nesting occurs, nesting season is between March 1 and October 31.

For best viewing of crawls, nesting surveys should begin shortly after sunrise but never earlier than ½ hour before sunrise. Because of potential disturbances to nesting females and the difficulty of locating and interpreting crawls in the dark, nesting surveys may not be conducted at night.

Surveyors should traverse the beach along (and seaward of, if possible) the most recent high tide line. This is important not only for ensuring that turtle crawls are not obscured before they can be evaluated, but also for avoiding impact to nesting Wilson’s plovers and other nesting shorebirds. Surveyors should become familiar with and keep alert for shorebird chicks in the intertidal zone as well, since they use this habitat once they leave their nests. For additional information on how to identify and protect shorebirds, contact FWC’s Division of Habitat and Species Conservation at (850) 488-3831. You can also contact the USFWS (USFWS, Migratory Birds and State Programs, 1875 Century Boulevard, Suite 240, Atlanta, GA 30345-3301).

Upon discovery of a crawl, surveyors should make a visual determination as to whether the crawl was a nesting emergence (i.e., a nest) or non-nesting emergence (often called a “false crawl”); they also determine what species of turtle made the crawl. All crawls should be recorded on a data sheet. If a crawl is clearly identifiable as a nest and the nest does not have to be screened, caged, precisely marked, or relocated, the surveyor should not dig into the nest simply to verify the presence of eggs. After each crawl is evaluated and documented, the tracks should be marked to avoid duplicate reporting. To accomplish this, a surveyor may obliterate a section of the upper track (not the nest site) by sweeping his/her feet across the track (Figure 2-1) or by crossing over the track (well above the high tide mark but not over the clutch) with a survey vehicle (Figure 2-2).

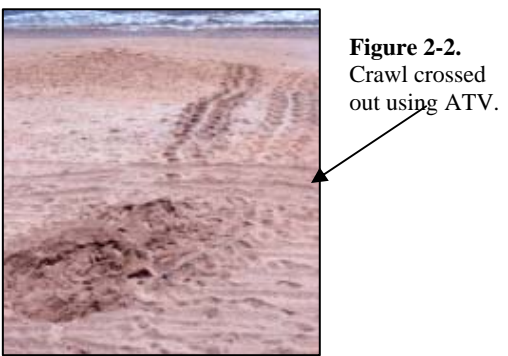

Nesting surveys may only be conducted within the boundaries specified on the permit. Ideally, boundaries should not change, either within a season or from year to year. Requests for expansion of authorized nesting survey areas must be submitted in advance and in writing to FWC, Imperiled Species Management. It is imperative that survey areas do not overlap. Please inform FWC immediately of any reduction in survey efforts so that steps can be taken to ensure continuity in nesting beach coverage. It is extremely important that FWC be informed of any changes in monitoring effort in order to maintain accurate and consistent nesting survey records.

Survey boundaries should be permanent and specific. GPS coordinates are highly desirable, in addition to physical landmarks such as state roads, county lines, etc. Street addresses are preferable to condominium names, which may change at any time. FWC has latitude and longitude coordinates, most collected with differentially corrected GPS, for every INBS beach and for all zones within these beaches. If INBS zone markers are lost, contact FWC for the coordinates that would allow correct repositioning of missing zone markers.

SPECIES IDENTIFICATION AND DETERMINATION OF NESTING SUCCESS

The tracks and other evidence left on the beach after a sea turtle has emerged (crawls) can be used to identify what species of turtle came up and whether or not it nested. The following outline describes how to use crawl evidence to make these identifications.

I. Identify which is the incoming (emerging) track and which is the outgoing (returning) track?

- As a turtle crawls it pushes sand backward with each flipper stroke.
- If one track is shorter, it will be the incoming track (Figure 2-3).
- If tracks overlap, the outgoing track will be on top.

Figure 2-3. Incoming vs. outgoing track (this turtle had a right rear flipper injury).



- ### II. What species made the crawl (loggerhead, green turtle or leatherback)?
- Note: Although hawksbills and Kemp's ridleys occasionally nest on Florida beaches, nesting is rare and their crawl and nest-site characteristics are similar to the loggerhead. Minimal discussion will be provided below for hawksbills and Kemp's ridleys. (Track widths listed below for

loggerhead, green turtle and leatherback were provided by Erik Martin, EAI. All artwork was provided by Dawn Witherington).

- A. Figure 2-4: tracks from a sea turtle with an alternating gait, no tail drag mark, and track width typically ranging from 70 to 124 cm (27.6 to 48.8 inches) with a mean of 94 cm (37.0 inches): **loggerhead turtle** (*Caretta caretta*). Species with similar tracks: hawksbills (*Eretmochelys imbricata*) typically leave a wavy tail-drag mark near the track center (Figure 2-5) and hawksbill track widths typically range from 70 to 85 cm (27.5 to 33.5 inches). Kemp’s ridley (*Lepidochelys kempii*) seldom leave a conspicuous tail-drag mark and a ridley track width ranges from 70 to 80 cm (27.6 to 31.5 inches). Both hawksbills and Kemp’s ridleys crawl with an alternating gait, like loggerheads. Kemp’s ridleys are predominantly daytime nesters. If you find a turtle nesting during the daytime, be sure to look at it closely (and take pictures if possible) to determine its species. Kemp’s ridleys also pack the sand down by rocking their bodies from side to side during nest covering (unlike the other species that use their rear flippers to “knead” sand to compact it).

Figure 2-4. Loggerhead track

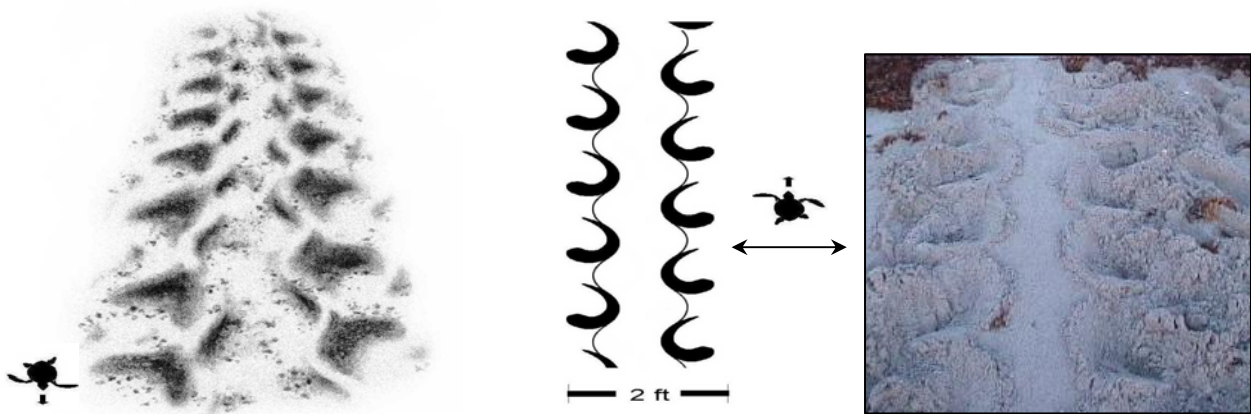
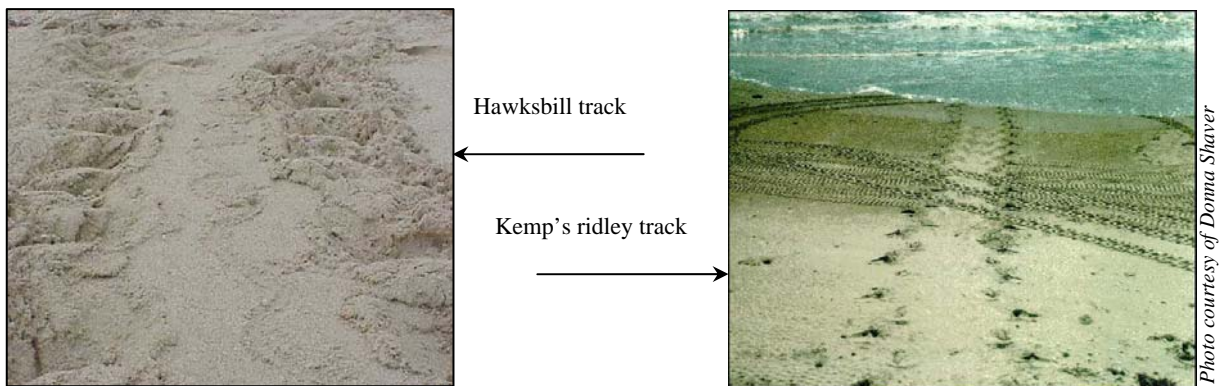

Figure 2-5. Hawksbill and Kemp’s ridley tracks.



et

- B. Figure 2-6: tracks from a sea turtle with simultaneous limb movement, a center drag mark from the tail (the center drag mark may be a solid or broken line), and track width typically ranging from 95 to 144 cm (37.4 to 56.7 inches) with a mean of 119 cm (46.8 inches): **green turtle** (*Chelonia mydas*).

Figure 2-6. Green turtle track

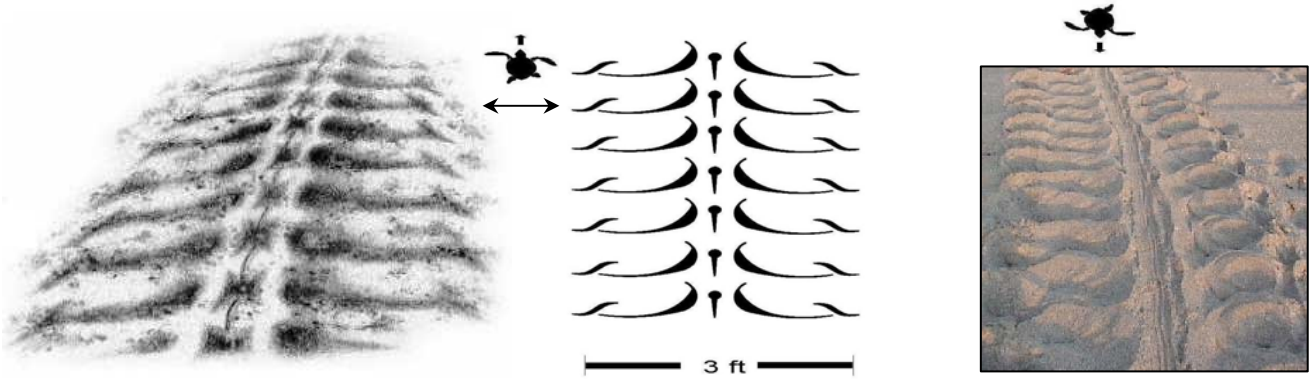

- C. Figure 2-7: tracks from a sea turtle with simultaneous limb movement, a center drag mark from the tail, and track width typically ranging from 175 to 214 cm (68.9 to 84.3 inches) with a mean of 196 cm (77.2 inches); track path sometimes circling or sinusoidal (S-shaped): **leatherback turtle** (*Dermochelys coriacea*).

Figure 2-7. Leatherback track

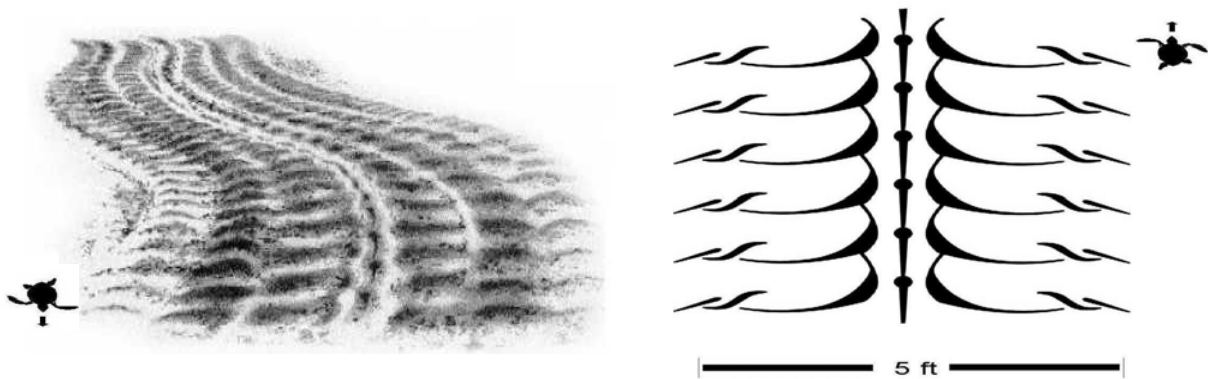

Note: Flipper injuries to turtles may alter track appearance (Figure 2-8). Characteristics of the nest (given below) should be used in conjunction with track characteristics to identify species.

Figure 2-8. Loggerhead turtle track with right rear flipper injury.

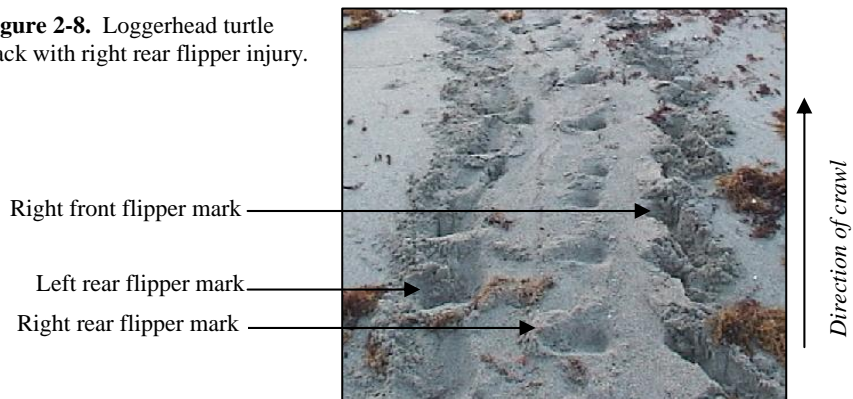

III. If the crawl is from a loggerhead, is it a nest or a non-nesting emergence? It is important to record both types of emergences. One should NOT dig into the nest to confirm the presence of eggs unless the nest is to be screened, caged, or marked for later determination of hatching success.

- A. Identify emerging and returning tracks by their direction (see I. above).
- B. Follow the path taken by the turtle and look for the following attributes.
 1. Evidence of covering the nest with the front flippers (Figure 2-9). If present, the crawl can be considered a **NEST**.
 - a. Presence of a secondary body pit and/or escarpment.
 - b. Sand "misted" or "thrown" over the emerging track.
 2. Evidence of an abandoned nesting attempt. If present, the crawl can be considered a **NON-NESTING EMERGENCE (i.e., false crawl)**.
 - a. Very little or no sand disturbed other than tracks (Figure 2-10).
 - b. Back stop with sand pushed back (not thrown) over emerging crawl, typically between two mounds of sand piled by the front flippers during construction of the primary body pit (Figure 2-11).
 - c. Considerable amount of sand disturbed from a digging effort, but with the crawl exiting the disturbed area and continuing toward the dune before turning toward the ocean (Figure 2-12).
 - d. Considerable amount of sand disturbed from a digging effort, but with a smooth-walled or abandoned/open egg chamber (15-25 cm diameter) in the center of a pit within the disturbed area (Figure 2-13).

Figure 2-9. A loggerhead nest site showing a secondary body pit (A) and a mound of thrown sand that is wider than the track.

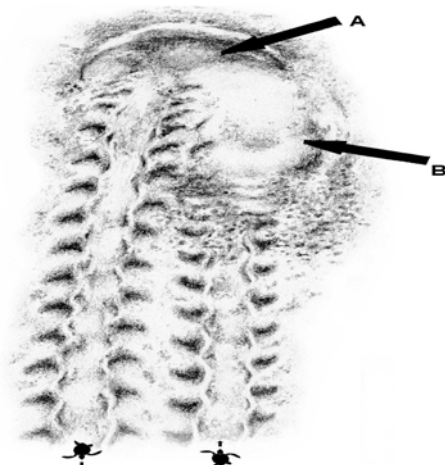

Figure 2-10. A loggerhead false crawl showing no evidence of disturbed sand other than the track.

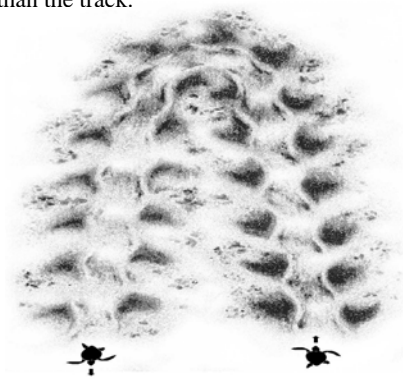

Figure 2-11. A loggerhead false crawl showing a small abandoned primary body pit (C) and a mound of pushed sand (D) no wider than the track and lying between two conspicuous ridges.

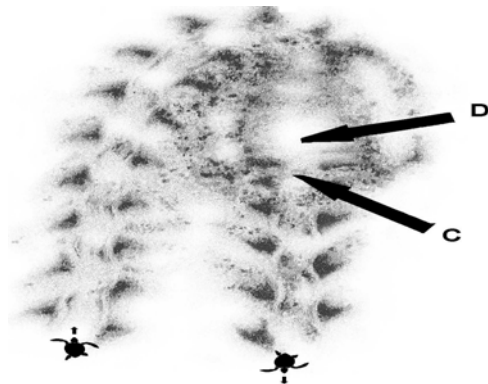

Figure 2-12. A loggerhead false crawl showing an abandoned primary body pit (C) and a mound of pushed sand (D) no wider than the track and lying between two conspicuous ridges. As is rarely found in nests, a track continues up the beach from the site where the turtle's last digging occurred.

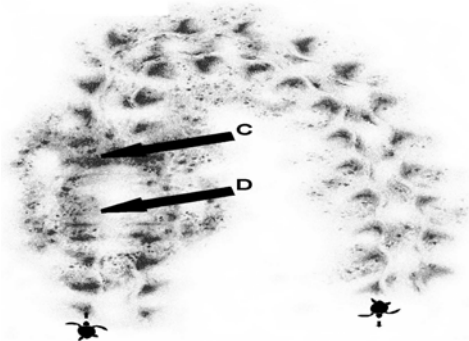
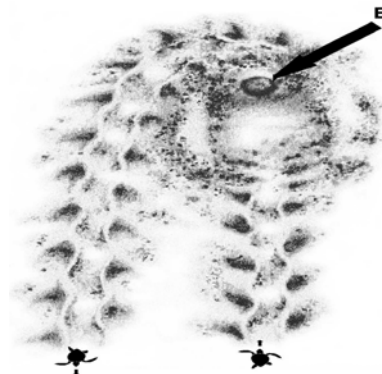

Figure 2-13. A loggerhead false crawl showing a primary body pit with an abandoned egg cavity (E).



IV. If the crawl is from a green turtle, is it a nest or a non-nesting emergence?

- A. Identify emerging and returning tracks by their direction (see I. above).
- B. Follow the path taken by the turtle and look for the following attributes.
 1. Evidence of front flipper covering. If present, the crawl can be considered a **NEST**.
 - a. Sand thrown into a mound covering more than 2 m of the emerging track and a deep (20-50 cm) secondary body pit with an escarpment (Figure 2-14).
 2. Evidence of an abandoned nesting attempt. If present, the crawl can be considered a **NON-NESTING EMERGENCE**.
 - a. Very little or no sand disturbed other than tracks (Figure 2-15).

- b. Less sand thrown over the emerging track and a smaller body pit than described in 1a above.

Figure 2-14. A green turtle nest site on an open beach showing a secondary body pit (A) and a mound of thrown sand (B) that is greater than twice as long as the visible secondary body pit. Note that smaller nest mounds are expected when obstacles or vegetation impede digging.

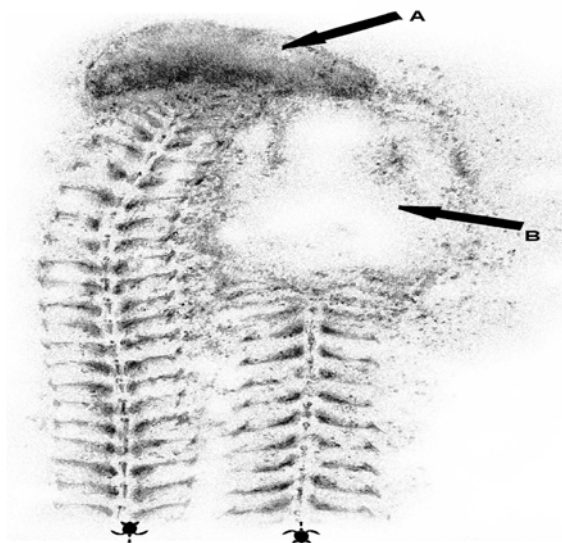
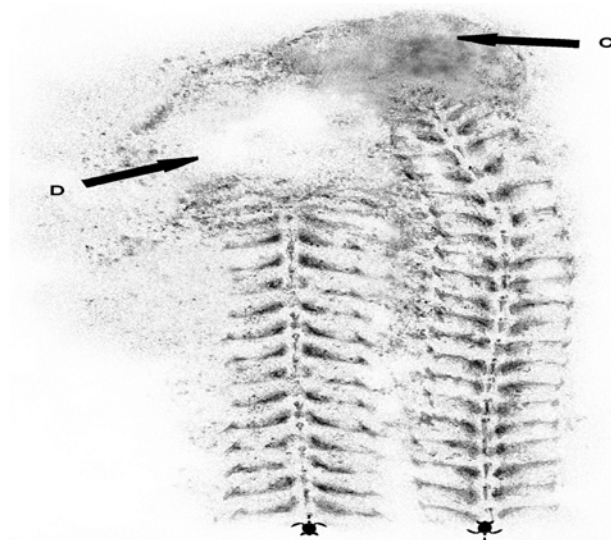

Figure 2-15. A green turtle false crawl on an open beach showing an abandoned primary body pit (C) and a mound of thrown sand (D) that is smaller than twice as long as the visible primary body pit. Note that many green turtle nests may have body pits and nest mounds that look similar to this.



V. If the crawl is from a leatherback turtle, is it a nest or a non-nesting emergence?

- A. If the disturbed sand in the crawl covers a large expanse of beach (>4 square meters) with sand thrown in multiple directions, the crawl can be considered a **NEST**.
- B. If the crawl is less extensive than in A, the crawl can be considered a **NON-NESTING EMERGENCE**.

Note: The extent of the excavations described for all species above will be influenced by vegetation, sand compaction, and objects encountered by turtles while digging. There is some variation in the behavior of turtles, and the above guidelines will not lead to a correct determination in every case. They are offered solely to help you with the task of determining whether a nest has been made.

NEST MARKING

Not every sea turtle nest needs to be marked. Marking is necessary for protection from hazardous activities being conducted on the beach or to obtain information on reproductive (hatching) success. Nest-marking methods for each of these two objectives are slightly different. Please keep in mind when driving stakes that at least some undiscovered and/or unmarked clutches are probably present on every beach. Drive stakes with caution.

1. Marking nest sites to protect buried eggs from hazardous activities

The goal of this marking method is to clearly identify the nest area and protect it from human activities such as beach cleaning, vehicular traffic, or construction. Any such construction activity that occurs on the nesting beach during nesting season, including beach cleaning, must have a valid permit from the DEP (see Section 1 for additional information on construction permitting). Activities such as the placement of beach furniture may, at the discretion of DEP, be exempted from permitting.

If at all possible, visually inspect the site to determine whether a nest exists. We do not recommend that nests be dug into simply to verify the presence of eggs. If you are not sure whether eggs were deposited, be conservative and mark the area as a nest. The entire disturbed area (where digging has occurred) should be delineated with stakes (Figure 2-16). Construction permits generally require that the nest site be marked with a radius of at least three feet, centered at the approximated location of the clutch. The stakes should extend about 36" above the sand. To further identify the nest site, surveyor's ribbon can be tied from the top of one stake to another to create a perimeter around the nest site. Additionally, a nest sign can be attached to one of the stakes used to create the perimeter (signs are available from FWC - see Appendix C). A nest-identifying number and the date the eggs were laid should be placed on at least one of the nest perimeter stakes. At least one additional stake should be placed a measured distance from the clutch location at the base of the dune or seawall to ensure that future location of the nest is possible should the nest perimeter stakes be lost.

Figure 2-16. Entire disturbed area of nest site marked.

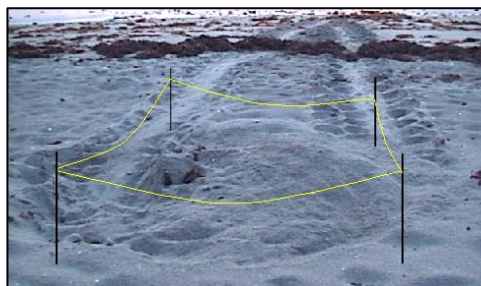

2. Marking nest sites to determine hatching success

The goal of this marking method is to allow an investigator to locate the clutch in order to evaluate the hatching success of a nest. Nests should be marked by locating the precise location of the clutch at a fresh nest site by carefully digging shallow, finger probing holes into the nest, by finger-probing for softer sand over the clutch, and by verifying the location of the eggs. Digging into a nest may alter the incubation environment if not done carefully and with lengthy training. It is preferable to avoid digging into a nest site unless the nest will be screened, caged, relocated, or marked for hatching success.

Figure 2-17. Approximate location of egg chamber in a typical loggerhead nest.



To locate the clutch in a fresh nest, note the characteristics of the nest site to predict the location of the clutch. To approximate the location of a loggerhead clutch, follow the tracks emerging from the water and leading towards the nest site. Commonly, the clutch is located about two feet into the broad disturbed area (the nest mound) from this approach; it is generally centered between the edges of this area. To estimate the location of a green turtle clutch, measure about three feet back from the escarpment created by the final covering activities. On leatherback nests, measure about 4.5 feet from the escarpment created by the final covering activities.

To precisely locate the clutch within the approximated area, dig gently and systematically by hand into the nest site. Focus the digging effort at the center of the mound of sand that was piled by the nesting turtle. Probe with fingers only, feeling for the softer (less compact) sand that will be on top of the clutch. Do not use shovels or any other tools. Once the soft sand is found, and the eggs beneath are verified, fill the hole with moist sand and gently pat the sand surface above the eggs with your hand. Replace the dry sand over this area to the depth present before you began, and place a temporary marker over the clutch site. Rebury any other holes dug in the nest site so that the nest site is restored to its original condition.

To mark the nest site, measure the exact distance from the precise or approximate clutch location to two separate marking stakes on the dune that are aligned so that a straight line between them orients directly toward the location of the clutch (Figure 2-19). If the clutch location is approximate, note the distance between the approximate clutch location and the edges of the disturbed area in each of four opposite directions. Both stakes should be labeled with an identifying nest number and the date the eggs were laid. On beaches where removal of marking stakes by the public is a potential problem, an additional stake, driven deeply and hidden from view, should be placed a measured distance landward of the first two. As added insurance, an aluminum marker can be buried hand-deep and 24" from the approximate clutch location in a standardized direction. This metal marker can be found later with a metal detector.

Figure 2-19. Site A stakes are directly landward of the nest in dune vegetation or at the base of a seawall. Site B stakes are in a similar position as Site A but located at an angle from the nest. Stakes A-1 and B-1 should be sunk deeply so that they are not conspicuous to someone not looking for them. Precisely measure the distance from stakes to the clutch location. Then, sink additional stakes (A-2 and B-2) directly between the clutch and the dune stake(s).

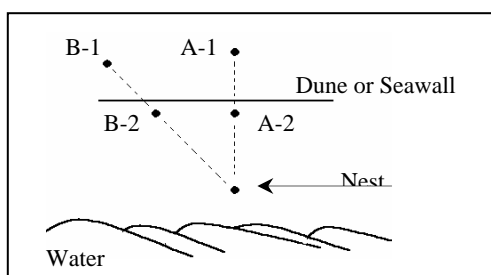

SECTION 2 – NESTING BEACH SURVEY ACTIVITIES

Use the marking stakes to find the egg chamber. Many times, a clutch may not produce hatchlings and the location of the clutch will not be indicated by the conspicuous signs of hatchling emergence. Moreover, some hatchling emergence evidence near the nest site may be from a nest other than the one that was marked for hatching success. To accurately determine overall hatching success, it is very important that the clutches from all marked nests be found and evaluated. A nest from which hatchlings did not emerge will be more difficult to locate again, but an inability to find these nests, and their exclusion from the sample representing one's beach, will result in overestimating hatching success for the beach. Please make the greatest effort possible to locate all nest cavities after waiting the appropriate length of time.

HATCHING SUCCESS EVALUATIONS (NEST INVENTORIES)

Hatching success must be determined for all caged, screened, and relocated nests. Hatching success may also be conducted on all other nests or on a sample of nests on the beach. A hatching success evaluation involves the excavation and inventory of a post-emergent nest to determine the fate of each egg. Because sea turtle eggs are subjected to a variety of incubation environments, including many that are affected by human activities, we encourage you to conduct nest inventories for hatching success on a representative sample of the nests in your survey area each year.

Selecting Nests To Mark for Inventory

A proper, representative sample of nests will allow assessments of hatching success that can be compared to other beaches and to other nesting seasons. To properly represent the beach, nests in a marked sample must be chosen by a system that removes seasonal, spatial, and observer bias. A sample of nests that is not properly representative can over- or under-represent certain zones on the beach or certain portions of the season. For example, a sampling strategy whereby a set number of nests are marked each day will always under-represent the middle of the nesting season. A sample of nests that is poorly representative, no matter how numerous, will yield potentially misleading information about hatching success.

Like selecting a representative sample of nests, it is also important to use (monitor and inventory) nearly every nest in the sample. Because the most difficult-to-find nests often have the poorest hatching success, the more these nests are excluded from a sample, the more the sample paints a rosier picture of hatching success than actually exists. Before giving up on finding a sample nest, one should feel confident that they know the fate of the nest and that failure to find it is due to its destruction (e.g., from erosion) and not due to imperfections in nest-marking techniques (e.g., stakes washing away from a surviving nest).

The best way to select a representative sample of nests is to decide in advance which nests of the season will be in the sample. If all nests on the beach can be marked and inventoried, then this selection is simple; mark and inventory all nests (but be sure not to overestimate how many nests can be sampled; marking nests is easy, inventorying them is difficult). However, if only part of the nests on a beach can be sampled, then every n^{th} nest should be marked as a sample nest. With this technique, “ n ” is a number that sets a pace for nest marking that results in a sample size that is adequate, but not too large to handle. Here are some examples of how to use this technique:

On beach A, surveyors feel they can mark, monitor, and inventory about 100 nests. In an average season, this beach gets about 2000 nests. Here, marking every 20th nest will reach the goal if the season is average. Note that the 20th nest is independent of the date of the season. For example, if on the first day of the season there are 19 nests, the first marked sample nest will be the first nest encountered (nest number 20) on the second day of the season. The second sample nest will be the 40th nest, the third will be the 60thetc.

Using a subtle modification to the above technique, some surveyors may wish to mark sample nests only one day per week. This is fine. To adjust the sampling protocol, divide your “ n ” by seven to determine what nests to mark on the one day per week when nest-marking is done. For example, if

your calculations are that every 35th nest at your beach needs to be marked in order to keep a pace that would result in 100 nests marked, then every 5th nest marked one day-per-week would keep the same pace and give an adequate sampling of nests. This math gets only slightly more difficult if the “n” for the beach is not divisible by seven. For instance, if 2500 nests are expected, and 100 sample nests are needed, (which gives a daily pace of marking every 25th nest) then the pace for marking nests one day-per-week would be 25 divided by 7, or every 3.6th nest. Of course, there are no fractional nests. In this case one can approximate a pace to achieve 100 nests by choosing two alternating n’s that bracket the number calculated. In this case, three and four bracket 3.6, and a proper pace would be to mark the 3rd, then 7th, then 10th, then 14th nests...etc. FWC staff can help with any questions on proper sampling of nests for hatching success.

Marked nests should be monitored on a regular basis, preferably each morning during the incubation period. Predation to the nest and other significant events should be noted. It is important to give marked sample nests the same treatment as other nests. Do not relocate, screen, or cage a nest just because it is a sample nest. During sample-nest monitoring, treat sample nests like other nests, that is, “clean up” depredated sample nests only if this practice is carried out for all other nests.

Nest Inventory

To conduct a nest inventory, begin by excavating the nest. Carefully dig down into the nest chamber with your hands until you reach eggs or eggshells. Do not use shovels or other tools. If you encounter live hatchlings before reaching any eggs or eggshells, the hatchlings have probably not finished emerging. Quickly cover the egg chamber with moist sand and return the site to its original condition. Wait at least 24 hours before excavating again.

Carefully remove the contents of the nest and place them in a pile on the sand or in a tray for easier sorting (Figure 2-20). Separate the contents into the following categories: hatched eggs (empty eggshells), live hatchlings, dead hatchlings, pipped eggs with live hatchlings, pipped eggs with dead hatchlings, and unhatched eggs (Figure 2-21). In pipped eggs, the turtle has broken through the egg but the hatchling is not completely free of its eggshell. Pipped eggs range from those with just a small hole to those with large tears.

Figure 2-20. Excavation of a post-emergent nest.

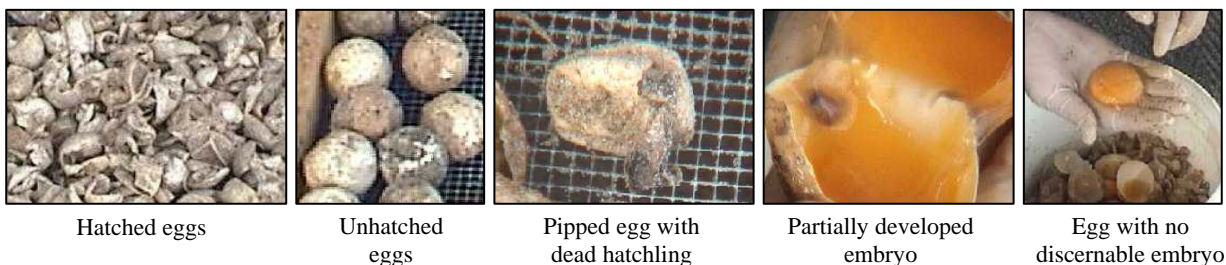

Figure 2-21. Categories of the contents of a nest.

Determine and record the number of eggs that hatched by carefully counting the eggshells (Table 2-1). Count each eggshell that is more than 50% complete as one hatched egg and disregard the smaller pieces. Be sure that all the eggshells are completely separated from each other. Record the number of live and dead hatchlings. These will account for some of the hatched eggs. The rest of the hatched eggs represent hatchlings that emerged from the nest. To determine the number of hatchlings that emerged from the nest, subtract the sum of live and dead hatchlings from the total number of hatched eggs. The sum of the live, dead, and emerged hatchlings should equal the number of hatched eggs.

Next, determine and separately record the number of pipped eggs with live hatchlings, the number of pipped eggs with dead hatchlings, and the number of unhatched eggs. Finally, determine the number of eggs originally present in the nest by adding together the hatched eggs, the pipped eggs, and the unhatched eggs. After completing the nest inventory, the nest contents can be reburied within the original egg chamber.

Table 2-1. Contents of a Post-Emergent Nest			
Hatched eggs		=	98
Live in nest		=	3
Dead in nest		=	1
Live pipped		=	0
Dead pipped		=	1
Unhatched eggs		=	5
No discernable embryo		=	3
Partially developed embryo		=	1
Fully developed embryo		=	1
TOTAL # EGGS		=	104

A nest inventory may only be conducted either 72 hours after the first sign of emergence or 70 days after the eggs were deposited (80 days for leatherbacks), whichever occurs first. Digging into a nest before some hatchlings have emerged may adversely affect these hatchlings. Because cooler

temperatures sometimes delay hatching and emergence, a nest that has been subjected to inundation, excessive rainfall, shading, or cool fronts, should not be excavated until 80 days after egg deposition or 96 hours after the first emergence. It is important to allow all hatchlings to emerge naturally before excavating the nest.

Note: If the first emergence of a nest has occurred (more than 3 hatchling tracks) and the hatchling tracks indicate a clear sign of disorientation you should contact the property owner responsible for the offending light(s), explain the situation, and ask them to turn the light(s) off. If the property owner cannot be reached or is not receptive to turning off the light(s) you may place a temporary restraining cage over the nest to contain the next emergence of hatchlings (see requirements for caging on page 2-22).

For the subsampling technique to succeed, a sampling plan based on the total number of nests expected has to be devised before the nesting season so that the sample of nests marked for evaluation will represent hatching success over the entire nesting season and nesting beach. The easiest way to do this is to mark for evaluation all nests made every other day, or every three days, or every five days, etc. (for a statistically valid sample, you should try to mark and evaluate at least 100 nests). Once a sampling plan is initiated, it should be followed throughout the nesting season. FWC sea turtle program staff is available to assist you in developing the best approach for your particular survey area.

When a nest marked for evaluation is completely depredated (all the eggs are destroyed), record this (no further evaluation is necessary). This nest is a very important part of your sample to accurately determine overall hatching success. Do not select another nest as a replacement. When a nest marked for evaluation is partially depredated, remove and count the depredated eggs. Cover the egg chamber with moist sand, and return the site to its original condition. Record the nest as partially depredated and record the number of eggs that were depredated. Then, at the appropriate time, inventory the remainder of the nest.

During nest inventories, some live hatchlings or pipped eggs with live hatchlings may be encountered. If this happens often, try waiting a day or two longer before conducting the inventory. Pipped eggs with live hatchlings or live hatchlings that have prominent yolk sacs may be carefully reburied at the top of the egg chamber or held on moist sand (not in water) until ready for release. If pipped eggs or hatchlings are held on moist sand, they are to be kept in a darkened, quiet, temperature-controlled area. When ready, these hatchlings are to be released on the beach at night and allowed to crawl to the water. See the following section for more information on the rescue and release of live hatchlings.

REPORTING REQUIREMENTS

The principal permit holder is required, by Florida Administrative Code, to submit sea turtle nesting summary reports to FWC immediately following each nesting season. Summary forms for data reporting will be mailed annually to all permit holders authorized to conduct nesting surveys. Surveyors who take part in nest marking and nest inventory for the Hatchling Productivity Index should complete the Nest Productivity Worksheet (data recorded on an electronic Excel worksheet and itemized for individual nests) given out as part of the annual

SECTION 2 – NESTING BEACH SURVEY ACTIVITIES

nesting survey workshop. All INBS beaches and other SNBS beaches that can meet these detailed reporting requirements may participate in the Hatchling Productivity Index. Contact FWC with questions about this program and about the annual nesting workshops.

HATCHLING RESCUE AND RELEASE

This activity includes salvaging live hatchlings (primarily disoriented hatchlings or those found at the bottom of excavated nests) and ensuring that they reach the water safely. Hatchling rescue and release does not authorize permit holders to conduct public hatchling releases. See Section 7-4 for information on conducting public hatchling releases.

Due to the short duration of the hatchling frenzy period, hatchlings should be released as soon as possible following rescue. All hatchlings found during darkness are to be released immediately. Small numbers of hatchlings (<5) that are found disoriented or at the bottom of nests during daylight excavation may also be released on the beach immediately (but no later than 9 am). Otherwise, rescued hatchlings must be released the following night. Hatchlings collected from excavated nests should never be held in water. Small Styrofoam or plastic coolers lined with damp sand work well as temporary holding containers. The lid of the cooler should be placed loosely over the top to provide a near-dark environment. Once placed in a holding container, hatchlings should not be handled or disturbed until they are ready for release. Activity causes increased expenditure of limited energy stores.

When choosing a release location, select a location that is as close to the original nest site as possible. It is also important to evaluate the lighting conditions at the potential release location. Any release location should be a relatively dark beach without light sources directly visible from the beach. Recent studies have shown that in-water predators will shift locations to areas of higher hatchling prevalence, resulting in unnaturally high concentrations of predators and increased probability of hatchling mortality (Wyneken *et al.* 2000). In order to prevent this type of increased risk, release locations should be varied regularly. Hatchling release should not be attempted on nights that exhibit either no wave action or significantly above average wave action as hatchlings may experience difficulty with orientation or wave navigation.

At the time of release, hatchlings should be placed on the beach at a distance from the waterline that is roughly equivalent to the original nest site and allowed to crawl to the water on their own. Lorne and Salmon (2007) suggest a distance of 13 m from the surf zone for loggerhead turtles on Florida's East coast. Artificial lights should not be utilized during hatchling releases. This applies to any members of the public observing such releases, as well as all permitted personnel involved in the release. A quick check of the release area with a small flashlight fitted with a red filter a short time after release will insure that all hatchlings have reached the water. Occasionally, individual hatchlings may need assistance in reaching the water. In such cases, they may be moved closer to the water's edge or placed in the shallows and allowed to swim off on their own. Individuals conducting the hatchling release should conduct a brief search of the surf zone and shallow water adjacent to the beach 10-15 minutes following the release to ensure that all hatchlings have swam away. Any hatchlings that have not successfully departed the surf zone or nearshore waters should be recaptured and transported to the local rehabilitation facility.

In some cases, weak hatchlings may need to be held for slightly longer periods (1-2 days) to allow them to recover. However, holding hatchlings overnight should not be a routine event. If hatchlings require further holding, contact FWC to arrange for their transfer to an authorized rehabilitation facility.

HATCHLING AND ADULT DISORIENTATION

Although sea turtles do nest on beaches with artificial lights, there is much evidence suggesting that they prefer darker beaches. When sea turtles choose to nest on lighted beaches, their hatchlings are at great risk. In Florida, artificial lighting is probably the single greatest human threat to emergent hatchlings trying to reach the ocean.

Both hatchlings and nesting adults exposed to artificial lighting can be led in the wrong direction (become misoriented) or meander and circle (become disoriented). It is extremely important that sea turtle permit holders who conduct nesting surveys look for and document signs of disorientation. These events should be reported on the standard reporting forms (copy of form in Appendix A). Because we may be able to immediately resolve a lighting problem and thus avoid subsequent problems, it is very important that you inform the FWC Tequesta office of all disorientation events as soon as possible. You can fax the forms to Tequesta at: (561) 743-6228.

Some indirect tracks from adult turtles may not be due to artificial lighting. Adult females in search of a nesting site may wander on the beach for a period of time looking for a suitable nesting site. Leatherback turtles are known to make orientation circles on their way back to the ocean after nesting. A diagram of the crawl should be included with adult disorientation reports to help assess the actions of the turtle.

Wind and rain may obscure tracks, making it difficult to document hatchling disorientation. Still, every effort should be made to count the number of hatchlings disoriented. Counting the tracks farther from the nest, in the area where the tracks spread out, is generally a little easier than trying to count the tracks right next to the egg cavity.

Identifying the light source is also important. If the disorientation was documented during a morning survey, and if time and personnel permit, a subsequent nighttime lighting survey would be useful in identifying the light source. The address of the property, and the number, variety and location of lights are important to the local code enforcement persons and/or FWC. Several counties and municipalities have lighting ordinances. A list of local ordinances and contact numbers can be found in Appendix C. In cases where a local ordinance is in place, the local code enforcement person is generally responsible for ensuring compliance with the ordinance. In areas where there is no local ordinance, FWC tries to work with the property owner to correct the problem light(s). Please notify the local code enforcement office and/or FWC as soon as possible after a disorientation event.

PREDATOR CONTROL

Summary

Many native and introduced animals are known to prey on incubating sea turtle eggs and hatchlings. Common predators in Florida include raccoons, armadillos, coyotes, foxes, ghost crabs, feral hogs, dogs, cats, birds, and fire ants. Depredation is a part of the natural system and, to a certain extent, compensated by the high reproductive output of sea turtles. However, predators will sometimes become so proficient at finding and destroying nests that they may threaten all the nests on a beach. Resource managers may sometimes control predators such as raccoons by trapping and removing nuisance animals from the beach. Trapping animals can be controversial with the public and may not be an option for many permit holders. Oftentimes, animal depredation increases where organic debris has accumulated on the beach. To avoid attracting increased numbers of predators to the beach where nests are incubating, synthetic organic debris (i.e., trash) should be removed.

Protecting Nests From Mammalian Predators

Although raccoons are the most common predators of sea turtle nests in Florida, armadillos, coyotes, domestic dogs, foxes, and feral hogs may also be destructive to nests in some regions. They generally target nests either within the first few days after egg deposition or as the embryos pip out of their shells releasing odors (attractive to predators) as the fluids within the shell spill out. When depredation becomes a serious problem (as an approximate guide, when greater than 10% of nests are affected), measures should be taken to protect nests. The easiest method for controlling mammalian predation without killing the predators is to place a self-releasing screen or cage over threatened nests. Protocol for nest screening and caging is described on pages 2-20 through 2-24. Note that the use of cages and/or screens requires permit approval.

Protecting Nests From Fire Ants

Sea turtle nests may be invaded by fire ants during incubation, hatching, or emergence. Both imported and native fire ants of the genus *Solenopsis* have been identified as predators of sea turtle nests. Fire ant researchers believe that fire ants may be attracted to the initial mucous covering the eggs. Once they cue into this food source they establish foraging tunnels and regularly “check” on the eggs. Sometimes fire ants will forage up to 50 meters from their mound. When the turtles start pipping out of their shells, the foraging ants bring news back to the mound and then are followed back by reinforcements. This may take a while depending on how far the mound is from the nest site. Researchers also believe that fire ants can forage beneath the surface so you may not always be able to tell if a nest has been invaded. Nests deposited closer to dune vegetation are more likely to become invaded by fire ants.

It is important not to over-react to a potential or ongoing problem with ants. Some steps taken to protect nests from ants may be unnecessary and may do more harm than good. The easiest and safest way to help protect a nest from ants is to keep the nest site clean. Ants are attracted to organic debris. The more debris at or near a nest site, the more likely ants are to find the nest.

If a clutch is deposited near an active fire ant mound or if fire ants begin to forage near a nest and fire ants have killed hatchlings from nearby nests, then fire ant baits such as Amdro, Logic, or Award™ may be used to control the ants. Follow the application directions for these products. Do not put these baits directly over a clutch, keep their use minimal, avoid broadcast spreading, and

follow label directions carefully. The best time to apply these products is early in the morning or late in the afternoon/evening (because the products break down in sunlight and fire ants are most active when it is moderately warm (60-80°F). It is important to be sure that any ants that are treated with the control agents are those that actually threaten the nest. There are many native ant species that may look like the harmful fire ants but that do not cause problems for turtle nests. The presence of these ants may help to exclude the harmful fire ants.

If many fire ants are seen entering a nest that may be hatching or emerging, and fire ants have killed hatchlings from nearby nests, the nest may be excavated. Do not use a tool to dig. Use an old leg of panty hose or a similarly thin material to protect hands and arms during excavation. Follow the instructions in the guidelines for hatching success evaluations regarding the handling of pipped eggs with live hatchlings and/or pre-emergent hatchlings. An early nest inventory should be done only because of a severe, well-documented problem. By excavating a nest early, the hatching and emergence process is disrupted, and this may lead to diminished hatching success. Actions taken to control fire ants, including nest relocation and early excavation, are to be reported on the annual nesting summary forms.

NEST SCREENING

Summary

This section is specifically intended for those persons whose permit authorizes them to **protect nests with self-releasing screen/cage**. These personnel are also authorized to:

- **mark nests**

Personnel are not authorized to conduct the following activities unless specifically stated on their permit:

- **conduct nesting surveys**
- **relocate nests**
- **screen nests with restraining cage**
- **use a self-releasing hatchery**
- **use a restraining hatchery**
- **use any screening material with a mesh size that is smaller than 2" x 4"**
- **use probes (other than fingers) to locate clutches**

ACTIVITY DESCRIPTION

When a nest is at high risk of predation (by raccoons, foxes, feral hogs, coyotes, etc.), the eggs and pre-emergent hatchlings may be protected by placing a self-releasing screen over the nest. The screens used for this purpose are typically 4' x 4' pieces of 2" x 4" mesh welded wire (do not use screen with a smaller mesh size as it is likely to trap emerging hatchlings). This type of screen is large enough to keep mammalian predators out and allows hatchlings to escape from the nest unaided. The screen must be centered exactly over the egg chamber to make it less likely for mammalian predators to burrow to the eggs from the side of the screen. Anchoring stakes should be placed along the edge of the screen such that they do not come in contact with the egg chamber.

To find the location of the egg chamber within the body pit refer to the guidelines under NEST MARKING (Page 2-9). Temporarily mark the location of the egg chamber by carefully placing a marker (must be thin enough to pass through the mesh of the screen) a very short distance into the sand above the egg chamber. Be sure that this marker is not inserted into the egg chamber. Replace the dry sand over this area to the depth present before you began excavation. Your temporary marker should be tall enough to extend above the sand level.

Level the surface of the sand in a 4' x 4' square centered on your temporary marker. If the screen is to be buried, remove 2" of surface sand from the 4' x 4' square. Place the screen on the smoothed sand. Remove the temporary marker. Using hooked stakes, secure the four corners of the screen. You may use tent stakes or make your own stakes of rebar or some other durable material. Even though the corners of the screen should be well away from the egg chamber, do not drive the stakes at an angle in the direction of the egg chamber. If the screen was placed 2" below the normal sand surface, place the removed sand back on top of the screen after anchoring so that the egg chamber is at its original depth. In some areas, predators are very persistent and may dislodge screens with only four stakes. In this case, try using eight stakes and place the four additional stakes midway between the corners. If stakes are easily dislodged, longer stakes may be used.

Depending on the local situation, you may or may not want to mark screened nests. In some situations, if screened nests are not marked with an appropriate sign, a beach user is likely to discover the screen, think that it should not be on the beach, and pull it up. Marking screened nests may also be necessary to prevent people from inadvertently injuring themselves on the screen or on any stakes. Signs for marking screened nests are available from the Imperiled Species Management Section in Tallahassee (see Appendix C). In other situations, marking nests may attract unwanted attention while providing no benefits.

Because stakes and/or screens may become partially or completely dislodged, they should be checked regularly. During the period of anticipated hatching, screens should be checked each morning just in case hatchlings become trapped by them. Please remove all screens from the beach after hatchling emergence is completed.

REPORTING REQUIREMENTS

The principal permit holder is to report the total number of nests that are screened and the reasons for screening on the annual nesting summary forms. A nest inventory must be completed on every nest that is screened.

NEST CAGING

Summary

This section is specifically intended for those persons whose permit authorizes them to **screen nests with self-releasing screen/cages** or **screen nests with restraining cages**. These personnel are also authorized to:

- **mark nests**

Personnel are not authorized to conduct the following activities unless specifically stated on their permit:

- **conduct nesting surveys**
- **relocate nests**
- **use a self-releasing hatchery**
- **use a restraining hatchery**
- **use any caging material with a mesh size that is smaller than 2" x 4" unless authorized to protect nests with restraining cages or unless there is an area maintained along the seaward face of the cage from which hatchlings can readily escape**
- **use probes (other than fingers) to locate clutches**

ACTIVITY DESCRIPTION

When a nest is at high risk of predation (by raccoons, foxes, feral hogs, coyotes, etc.), the eggs and pre-emergent hatchlings may be protected by placing a self-releasing cage over the nest. When hatchlings at a nest site are certain to be disoriented by lighting, and the lighting cannot be resolved before the hatchlings are due to emerge, then the nest may be covered by a restraining cage to keep hatchlings from crawling toward lights. While the exact construction of cages may vary (see examples of two cages in Figures 2-22 and 2-23, all restraining cages are to provide enough room for all hatchlings to completely emerge from the sand. In all self-releasing cages, the 2" x 4" mesh of the cage must be oriented so that the 4" opening is parallel to the surface of the sand. If self-releasing cages are not constructed of a material with a mesh size that is 2" x 4" or greater, then they are to have, on the seaward face of the cage, a regularly maintained area from which hatchlings can readily escape. If hatchlings are to escape through an opening in the cage, the bottom edge of the opening may not extend above the sand's surface, the top edge of the opening is to be at least 2" above the sand's surface, and the opening is to extend along the entire seaward side of the cage. Cages are to be centered exactly over the egg chamber to make it less likely that mammalian predators will burrow to the eggs from the side of the cage, and to make sure that any anchoring stakes placed along the edges of the cage will not enter the egg chamber. To find the location of the egg chamber within the body pit refer to the guidelines for NEST MARKING, page 2-9.

Most cages are anchored by burying the outward pointing flanges (Figure 2-22) about one foot under the sand's surface. Center the cage over the egg chamber and trace the edges of the cage in the sand. The cage should be oriented so that the opposing sides of the cage are either parallel or perpendicular to the shoreline. Remove the cage and the temporary egg chamber marker, and carefully dig a one foot deep trench along the tracing of the edges of the cage. Place the cage into the trench and fill the trench with sand. When completed, the sand around the cage and over the egg

chamber should be at the original level. If stakes are used to secure a cage, drive the stakes at an angle away from the egg chamber. Signs for marking caged nests are available from FWC (see Appendix C).

Because cages may become partially or completely dislodged, they must be checked regularly. If a restraining cage is used, each cage must be checked for hatchlings at least twice a night beginning 45 days after the clutch was deposited and ending when the cage is removed. Restraining cages must be checked for hatchlings once between 11 p.m. and 1 a.m., and once between 5 a.m. and 7 a.m. After checking the nest during the latter period, restraining cages should be opened (see Figure 2-23) to allow hatchlings that may emerge during the day to escape the cage. These cages may then be closed again at sunset. All hatchlings that are discovered within restraining cages are immediately released at an appropriate beach site and allowed to crawl to the water. Remember, there must be a way to get hatchlings out of a restraining cage without pulling the cage off the nest. Self-releasing cages should be checked each morning during the period of anticipated hatching, just in case some hatchlings have become trapped. Please remove all cages from the beach after hatchling emergence is completed.

Figure 2-22. Example of a self-releasing cage. The cage is constructed of 2" x 4" welded utility wire. Hatchlings are able to escape through the mesh of the wire. Cage design courtesy of The Conservancy of Southwest Florida.

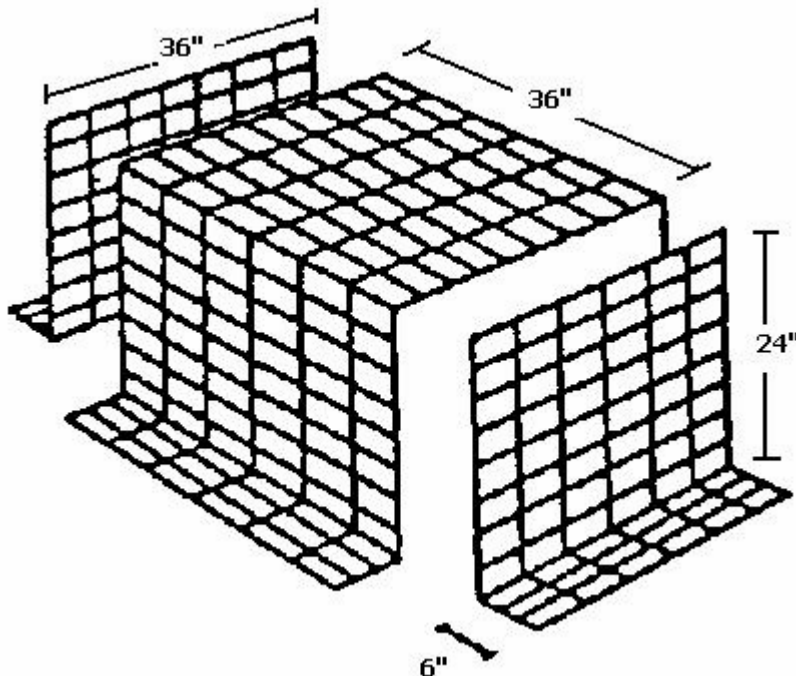
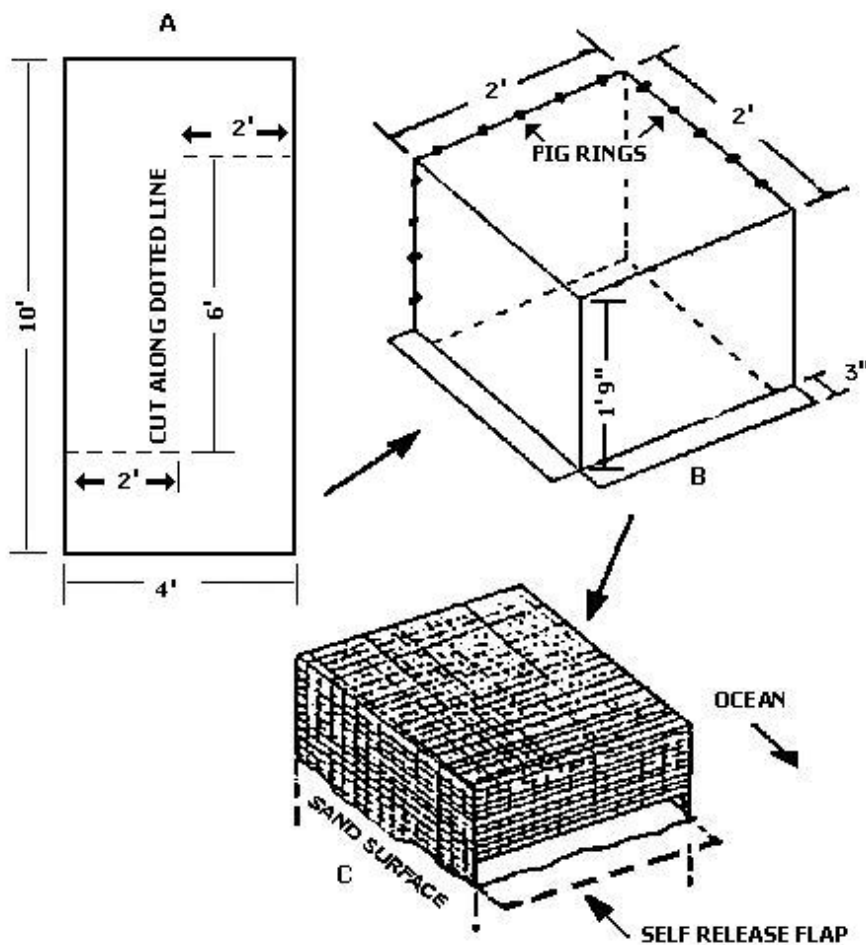

Figure 2-23. Example of a cage that can be either self-releasing or restraining. The cage is constructed of 1/2" galvanized hardware cloth. It becomes self-releasing if a 3" flap is cut along the entire bottom edge of the seaward side of the cage. This flap is folded outward and downward into a trench dug in front of the cage. The flap is then buried under no more than one inch of sand, leaving a 2" tall space through which hatchlings can escape. Restrained hatchlings are collected through a 6" x 6" flap cut in the top of the screened and secured by wire ties. Cage design courtesy of Ecological Associates, Inc.



REPORTING REQUIREMENTS

The principal permit holder is to report the total number of nests that are caged, as well as the type of caging used, and the reasons for caging on the annual nesting summary forms. A nest inventory must be completed on every nest that is caged.

NEST RELOCATION

Summary

This section is specifically intended for those persons whose permit authorizes them to **relocate nests**. These personnel are also authorized to:

- **mark nests**

Personnel are not authorized to conduct the following activities unless specifically stated on their permit:

- **conduct nesting surveys**
- **protect nests with self-releasing screens/cages**
- **protect nests with restraining cages**
- **use a self releasing hatchery**
- **use a restraining hatchery**
- **relocate a clutch at anytime after 9:00 AM the morning following deposition**
- **use probes (other than fingers) to locate clutches**

ACTIVITY DESCRIPTION

Moving sea turtle eggs creates many opportunities for adverse impacts. Movement alone is known to kill developing embryos by disrupting delicate membranes that attach to the inside of the egg. Because the incubation environment greatly influences the developing embryo, nest relocation can involve the transfer of eggs from an appropriate environment to an inappropriate one. For this reason, nest relocation is considered a management technique of last resort.

Natural events, like storms, that accelerate beach erosion and accretion can sometimes reduce hatching success in existing nests. While damage from storm events can be severe, it is difficult to predict the precise areas where the storm is most likely to inflict damage. Because of the negative effects of relocating eggs and the unpredictability of storm events, FWC does not generally authorize permit holders to move nests out of areas threatened by storms. As a general rule, nests should only be relocated if they are low enough on the beach to be washed daily by tides or if they are situated in well documented high-risk areas that routinely experience serious erosion and egg loss (e.g., nests laid near river mouths or beneath eroding sea walls).

FWC does not generally authorize nest relocation for heavy foot traffic, lighting problems or beach cleaning. Foot traffic is not known to cause problems for nests, but if traffic is heavy, a nest can be marked so that it will be avoided by pedestrians. If a nest is made near a light that may misorient the hatchlings, efforts should focus on getting the light turned off or shielded (if protection is necessary, the nest should be caged). If nests are deposited on beaches that are periodically raked with mechanical equipment, beach raking should be discontinued or the nests should be marked clearly so that they can be avoided by the beach cleaners.

When a nest does require relocation, the eggs must be moved no later than 9:00 AM the morning following its deposition. About 12 hours after deposition, the potential for movement-induced mortality in sea turtle eggs increases rapidly. Eggs should be moved no later than 12 hours after

deposition (turtles may nest as early as 9:00 PM the preceding night). To relocate a nest, find the location of the egg chamber by gently and systematically digging by hand, and probing with fingers only. Never use shovels or any other tools for either digging or probing. Once the eggs are located, carefully remove the sand from around the top eggs. Individual eggs should be gently lifted from the egg chamber and placed into a rigid container with a 2" - 3" layer of moist sand on the bottom. When moving eggs, be sure to maintain each egg's original orientation; do not rotate eggs in any direction and avoid abrupt movements. As eggs are placed in the container, be sure that they do not roll. Eggs are to be shaded if relocated after sunrise. The easiest way to do this is to lay an open umbrella on its side (because there may be eggs incubating nearby, do not stick the umbrella into the ground) or place a towel over the top of the container holding the eggs. When all eggs are in the container, cover them with a layer of moist sand.

Find a suitable nearby location on the beach that is successfully used by nesting turtles. Be sure that the new nest site is above the high tide level but not in dense vegetation. With your hands, dig a new nest chamber to the same depth, size, and shape of the original nest. The shape of the nest chamber should be such that there is a spherical bottom and a slightly narrower neck. The depth of a loggerhead nest chamber should be 18-22 inches and the diameter of the spherical bottom should be volleyball to basketball size. The neck should only be 2-4 inches more narrow than the bottom. Clutches that are greater than or less than average may require respective nest-chamber dimensions that are larger or smaller. Place the eggs in the new egg chamber by transferring them one at a time while continuing to maintain each egg's original orientation. After all the eggs have been transferred into the new egg chamber, cover them with the moist sand excavated from the egg chamber. Dry sand should not be allowed to fall into the egg chamber. Once the eggs are reburied to the upper level of the surrounding moist sand, gently pat the sand surface above the eggs with your hand. Replace the dry sand over this area to the depth present before you began. The relocated nest can then be marked and later evaluated for hatching success.

REPORTING REQUIREMENTS

The principal permit holder is to report the number of and the reasons for nest relocations on the annual nesting summary forms. A nest inventory must be completed for every nest that is relocated.

SECTION 3 - STRANDING AND SALVAGE ACTIVITIES

Summary

This section is specifically intended for those persons whose permit authorizes them to **conduct stranding and salvage activities**. These personnel are also authorized to:

- **transport or transfer live turtles, carcasses, or preserved material within Florida**

This activity does not authorize personnel to conduct the following activities unless specifically stated on their permit:

- **conduct necropsies**
- **hold turtles for rehabilitation**
- **transport or transfer live turtles, carcasses, or preserved material into or out of Florida (this activity requires a specific consent permit from FWC)**

Activity Description

This activity typically involves the collection of information on turtles that are found dead or debilitated. All permit holders participating in this program are required to complete a Sea Turtle Stranding and Salvage Network (STSSN) stranding report for each dead or debilitated turtle encountered. Completed STSSN forms should be faxed within 48 hours to the FWC Tequesta Field Office at (561) 743-6228. You do not need to put a cover sheet on the report, it will be routed correctly without a cover sheet. The fax machine will answer 24 hours a day, if you get a busy signal, please try back in a few minutes. If a fax machine is not available or practical, summary information should be reported within 48 hours by phone to FWC marine turtle stranding staff at Tequesta (561) 575-5407 or St. Petersburg (727) 896-8626. To avoid any long distance phone charges, you may also page stranding staff at 1-800-241-4653, then enter pager number 274-4867 and then enter your phone number **including area code**. The pager is monitored 7 days/week 8 am-8 pm. Someone will return your page and take the stranding information. FWC is required to report all strandings on a weekly basis to the National Marine Fisheries Service (NMFS). Additionally, timely notification of marine turtle strandings is essential to addressing mortality factors. In order to meet these requirements, which are very important for the conservation of marine turtles, you must notify us each time you document a stranded marine turtle. You must also mail the original of the completed STSSN form within one week to the FWC Tequesta Field Office at 19100 SE Federal Highway, Tequesta, Florida 33469. FWC stranding staff will provide all the blank STSSN reporting forms. Please do not make your own copies of blank forms.

Conducting stranding and salvage activities may also involve the collection of information on turtles that have been impacted by a human-related activity or situation but not necessarily killed or debilitated. A STSSN reporting form should be completed anytime a turtle is captured or trapped even if the turtle is released unharmed (the only exceptions occur when these captures or entrapments are already reported to FWC through other reporting forms or reporting requirements). A STSSN reporting form should be used to document any hazards encountered by nesting turtles on the beach (e.g., trapped under boardwalk, trapped under boat, trapped in rocks, ran into beach furniture, fell off seawall, wandered into a nearby road, wandered into road and got hit by car, became trapped behind the dune, etc.). A STSSN reporting form should be

completed for all post-hatchling wash-ins (turtles that have left the beach and then stranded; they are generally a bit larger than newly-emergent hatchlings, and may have algae, barnacle, or other epizoa present).

The efforts of the Florida STSSN are critical to the FWC conservation and recovery program for marine turtles. To maintain consistency and data quality, STSSN activities should only be conducted by highly experienced personnel with explicit training from FWC. All personnel conducting STSSN activities are to follow instructions and guidelines circulated by FWC in periodic STSSN updates. Please note carefully the following additional permit requirements:

1. A photograph is the single-most important piece of information you can generate from a stranding. Submit at least three photographs of each stranded turtle when you mail the original copy of the stranding report to FWC stranding staff in Tequesta. Take one close-up photograph of the turtle's head, one photograph of the dorsal surface of the turtle, and one photograph of the ventral surface of the turtle. If developing the photographs will take more than one week, then mail the original copy of the stranding report without the photographs and note on the stranding report that photographs will follow. When you have the photographs developed, please label them with your name, date of stranding, turtle number-by-day, and mail them to the FWC stranding staff in Tequesta. Polaroid cameras are available from the FWC stranding staff if you do not have a camera for photographing stranded marine turtles.
2. Do not dispose of any turtle carcasses that have tags or tag scars until someone with the FWC stranding staff in Tequesta or St. Petersburg is notified.
3. Do not dispose of any hawksbill, Kemp's ridley, or leatherback carcasses until someone with the FWC stranding staff in Tequesta or St. Petersburg is notified.
4. Do not dispose of any turtle carcass that has not been positively identified to species (classified as probable or unsure) until someone with the FWC stranding staff in Tequesta or St. Petersburg is notified.
5. If entangling materials are found on a turtle, take photographs of the turtle before the entangling materials are removed and take extra photographs of the entangling material, especially of any hooks or types of identification marks. Do not dispose of any entangling materials without taking proper photographs.
6. Do not dispose of any fresh (no smell) carcasses without notifying the FWC stranding staff in Tequesta or St. Petersburg. Attempts will be made to save as many of these as possible for necropsy.
7. Include a copy of a local map with each stranding report, showing the exact location of the stranding whenever the descriptive location of the stranding does not reference a major map feature (e.g., causeway, inlet, cape, point, etc.). Clearly indicate whether or not the stranding was found in or along offshore waters (Atlantic Ocean or Gulf of Mexico) or in or along inshore waters (passes, inlets, sounds, bays, lagoons, rivers, harbors, bays).

COMPLETING THE STSSN DATA REPORT SHEET

The following information is provided to assist with the proper completion of the STSSN reporting form (see copy of form in Appendix A-1). Permit holders conducting stranding and salvage activities are to be familiar with the following information and are to complete forms in an appropriate manner.

Observer's Name/Address/Phone: This is the person who handled and documented the turtle in the field. It is not the person who reported the turtle to you. Please include your full name with middle initial if you have one. Records are partially indexed by observer initials. We may need to contact you for clarification of the reported data; please give us an address and phone number where we can reach you.

Stranding Date: This is the date the stranded turtle was first reported or encountered by the initial observer. If you did not investigate until a later date, please make that known in the box at the bottom of the stranding form. The turtle number by day is used to keep track of more than one turtle (regardless of species) investigated on a single day by the same stranding participant. Your first turtle of the day is 01, second of the same day is 02, third of the same day is 03, etc.

Species: If you code a turtle as "unidentified", contact FWC turtle staff in Tequesta or St. Petersburg by telephone before you dispose of the carcass. If you are unable to contact FWC before you dispose of an "unidentified" turtle, please take several photographs from different angles. If the skull is present, please save it to be used for identification.

Location: Indicate whether or not the turtle was found along a shoreline of, or floating in, offshore waters (Atlantic Ocean, Gulf of Mexico) or was found along a shoreline of, or floating in, inshore waters (passes, inlets, sounds, bays, lagoons, rivers, harbors, bayous). When describing the location, be as specific as possible and use a known reference point. Local names or landmarks not found on nautical charts do not help us pinpoint a location. Good reference points are inlets, county lines, state boundaries, cape points, major roads that intersect the beach, etc. An example of a good, descriptive location is: "2.5 miles south of the Ft. Pierce Inlet on the ocean beach." The stranding location is one of the most important data items on the form. If you know that the location is difficult to describe and will be difficult for us to transfer to a nautical chart it will be very helpful if you include a copy of a map with the stranding location indicated. If the turtle was found floating, please indicate so. If you have access to current nautical charts and you know exactly how to plot and read positions, you may include the latitude and longitude of the stranded turtle. Positions are coded to the nearest tenth of a degree and recorded in the following format (e.g., 28°16.8'N and 80°36.3'W). LORAN positions can be converted, but it is better to submit a latitude and longitude. If you use a GPS unit to determine the latitude and longitude of a stranding please indicate this. In most cases, you will leave the latitude and longitude blank.

Condition of Turtle: If the turtle seems intermediate between two stages of decomposition, pick the one that fits best. If it smells bad at all, it is not fresh. If you have a fresh dead turtle (that does not smell bad), please contact FWC stranding staff at Tequesta or St. Petersburg as soon as possible.

Final Disposition of Turtle: These codes refer to what you did with the stranded turtle. To avoid duplicate reporting, you should never leave a turtle unpainted on the beach. At the very least, please paint the turtle and move it out of reach of the tide. The preferred method is to paint and then bury the turtle either on the beach or off the beach. During the nesting season you should dig only by hand or locate a spot off the nesting beach; if you dig by any method other than hand, you may dig into and destroy a nest. Codes 1-4 refer to dead turtles only. Codes 6 and 7 are for live animals. If you use code 6 (alive, released) please say where and when you released it in the box at the bottom of the reporting form. If you use code 7 (alive, taken to holding facility) please give the name and location of the facility the turtle was taken to at the bottom of the reporting form. Remember, only permitted rehabilitation facilities are allowed to receive injured turtles. If a turtle was found floating and was unable to be recovered, use code 8 (left floating). If none of the disposition codes fit the event you are reporting, please explain what you did with the animal in the box at the bottom of the reporting form. Paint all dead turtles unless you are salvaging the carcass for FWC.

Sex: This will most often be undetermined, as immature marine turtles cannot be sexed externally. Adult male turtles have a tail that extends well beyond the carapace. Generally, the sex of loggerheads and green turtles under 98 cm curved carapace length will be considered undetermined if a long tail is not present. If you determine the sex to be male, give a measurement for the length of the tail extending beyond the posterior edge of the carapace in the adjacent blank.

Tags: Check the turtle for tags or indications of lost tags. All flippers should be thoroughly checked and the carapace should be checked as well. If you encounter a stranded turtle with a tag, contact FWC turtle staff in Tequesta or St. Petersburg by telephone before you dispose of the animal. Researchers depend heavily on these rare events to learn important things about turtles. There may be something specific that needs to be done with the carcass. We may want to collect skeletal parts or the whole animal. If you are instructed by FWC to dispose of the carcass, always remove the tags before you leave the site and bury the turtle. List the tag number(s) and location (e.g., left front flipper). Enclose the tags in a padded envelope and submit them, along with the stranding report, to the state coordinator. All turtles with flipper tags or with tag scars should be scanned for PIT (internal) tags. If necessary, please contact FWC stranding staff in Tequesta or St. Petersburg to arrange for a PIT tag scan. Because all Kemp's ridley carcasses should be scanned for PIT and coded wire (also internal) tags and checked for the presence of living tags, all efforts should be made to transfer those carcasses to FWC stranding staff in Tequesta or St. Petersburg.

Carapace Measurements: Enter the measurement in the correct slot (straight or curved, length or width). Straight-line measurements are taken only with calipers. If you do not have calipers, please do not report straight-line measurements. Do not take straight-line measurements with a flexible tape measure. If you take straight measurements, please take curved measurements, as well. Be sure to circle the units you used as centimeters (cm) or inches (in). Methods of obtaining standard carapace measurements are depicted on the stranding form. Please indicate if your measurements are estimates.

Remarks: The box at the bottom of the page is a space for your notes. The more information you give us, the easier it will be for us to code the record. Use the back of the data sheet to continue your remarks. Always note anything unusual about a stranding event (some of these anomalies are listed on the data sheet). We will code these notes onto each turtle's record. Use the diagrams on the

STSSN form to indicate flipper damage, carapace wounds, tag locations, or anything else you want us to know about the turtle. Please do not leave this section blank. If there are no anomalies (peculiarities), please say so. If the turtle was caught in any type of gear, please indicate so, for example: “This turtle was caught hook and line.” or “This turtle was entangled in a crab trap line that was (or was not) attached to a crab trap.”

LIVE TURTLE TRANSPORT

If you need to transport a sick or injured marine turtle, it must be shaded and otherwise protected from extremes of heat and cold (not above 90°F and not below 50°F). If a turtle is transported at temperatures greater than or equal to 75°F, it should be cooled by keeping a wet towel on the carapace and by periodically pouring water over the head. Water and wet towels should not be used when transporting turtles at temperatures less than 75°F or at any time they are exposed to an air-conditioned environment. The only exception is that any open wounds should be kept moist with clean freshwater. At temperatures less than 75°F, turtles may be kept from drying out during transport by applying a thin layer of petroleum jelly (e.g., Vaseline®) to the carapace and all the soft tissues (except the eyes and any open wounds). The use of petroleum jelly is recommended only for small turtles (juveniles).

FWC stranding staff will often suggest the use of towels, water, or petroleum jelly when making transportation arrangements for each live turtle. The table below provides guidance in determining which treatment is most appropriate for any live turtle needing transport.

Ambient Air Temperature around Turtle	Duration of Transport (hours)	Barnacles or Other Epibiota present on carapace	Turtle Class Size	Recommended Treatment
75°F (or warmer)	Any	--	Any size	Wet towel or water mist
74°F (or cooler)	≤2 hours	--	Any size	Dry towel
74°F (or cooler)	≥2 hours	Carapace clear	Juvenile	Petroleum jelly
74°F (or cooler)	≥2 hours	Carapace clear	Sub-adult/Adult	Dry towel
74°F (or cooler)	≥2 hours	Large amounts of epibiota present	Any size	Dry towel

Any containers housing turtles during transport are to be padded and may not contain any material that could be accidentally ingested. Hatchlings and post-hatchlings should be transported in a container with moist sand; they should not be transported in water. The containers should be secured during transport such that they do not slide around or tip over.

CONDUCTING NECROPSIES

Summary

This section is specifically intended for those persons whose permit authorizes them to **conduct necropsies**. These personnel are also authorized to:

- **transport or transfer carcasses or preserved material within Florida**

Personnel are not authorized to conduct the following activities unless specifically stated on their permit:

- **conduct stranding and salvage activities**
- **hold turtles for rehabilitation**
- **transport or transfer carcasses or preserved material into or out of Florida (this activity requires a specific consent permit from FWC)**

Activity Description

Minimally, necropsy procedures are to follow the techniques set forth in the "Sea Turtle Necropsy Manual" by Richard E. Wolke and Anita George, NOAA Technical Memorandum NMFS-SEFC-24 (1981). The listing of necropsy as an activity on a permit does not imply that all listed personnel can conduct this activity. Only personnel with thorough training and demonstrated expertise in this area may conduct necropsies. Personnel who are authorized to conduct necropsies on stranded turtles (that have not been held in a rehabilitation facility) must contact FWC turtle staff in Tequesta or St. Petersburg before conducting a necropsy.

REPORTING REQUIREMENTS

A FWC necropsy report is to be completed for each marine turtle necropsied and the original submitted to FWC in Tequesta (see Appendix A-4 for a copy of the necropsy form).

TED TURTLES

Each year the National Marine Fisheries Service conducts turtle excluder device (TED) certification trials off of Panama City Beach, Florida. The turtles used in these tests are juvenile loggerheads that were collected from Florida's nesting beaches as hatchlings and raised for approximately two years specifically for the TED certification trials. Upon completion of the annual trials, the turtles are released. Some of the turtles released swim into the nearshore waters and are often observed by the public. FWC is interested in knowing about sightings of these turtles. Should you receive calls regarding small turtles that appear to be "friendly" toward people, we ask that you collect as much information as possible including flipper tag number(s), date and location of sighting, and the general behavior of the animal. Please report sightings in writing to the Imperiled Species Management Section office in Tequesta.

SECTION 4 – HOLDING MARINE TURTLES IN CAPTIVITY

SUMMARY

This section is specifically intended for those persons whose permit authorizes them to:

- **hold loggerheads for educational display**
- **hold non-releasable turtles**
- **hold turtles for rehabilitation**
- **hold turtles for research**

If any of the above activities are listed on the permit, personnel are also authorized to:

- **transfer or transport turtles within Florida after consultation with FWC**
- **conduct necropsies on turtles that die at the holding facility**
- **release turtles after consultation with FWC**

Permit holders are not authorized to conduct the following captive maintenance activities unless these activities are specifically listed on the permit:

- **tag turtles**
- **transfer or transport turtles into or out of Florida**
- **hold turtles for any reason other than that specifically stated on the permit (e.g., permit holders authorized only to hold turtle for rehabilitation may not conduct research on those turtles)**

ACTIVITY DESCRIPTION

The following care and maintenance standards provide minimum requirements for humane care and maintenance of all endangered and threatened species of marine turtles held in captivity under the permitting authority of the FWC. The permit holder shall maintain these standards as a requirement of continued authorization. Any inability to attain or maintain these standards shall be reported to the FWC immediately so an appropriate and a timely resolution of the problem can be made. Failure to notify the FWC or repeated inability to follow these standards, without specific exceptions granted in writing by the FWC, is considered a violation of the Marine Turtle Permit. All wildlife possessed under the authority of the Marine Turtle Permit shall remain the property of the State of Florida and under the primary jurisdiction of FWC.

HOLDING TURTLES FOR EDUCATION

Depending upon the display capabilities of a facility and proper justification, up to three loggerhead turtles (*Caretta caretta*) may be held solely for educational purposes by a facility that is primarily educational in nature, that is open to the general public at least five days per week, and that receives no less than an average of 100 visitors per week. The turtles shall be on display and the display is to be accompanied by interpretive signage that includes the following information: species

identification, protection status under the Endangered Species Act, general life history, and current conservation issues (e.g., ingestion of debris, ocean dumping, loss of nesting beaches, loss of developmental habitats and adult foraging grounds, beach lighting, incidental capture, boat strikes, etc.).

Wild turtles (bycaught, stranded, or congenitally deformed) that have been rehabilitated, but which have permanently handicapping injuries or defects that preclude their potential survival in the wild, should be used whenever possible for educational display, *in lieu* of healthy, releasable marine turtles.

If loggerheads are obtained as hatchlings, they shall be held until they reach a straight carapace length of at least 45 centimeters or a curved carapace length of at least 50 centimeters (measured from the nuchal notch to the posterior marginal tip). If a holding facility cannot maintain turtles until they reach this size, prior arrangements must be made with another facility to continue to hold the turtles until they reach the specified size. It is the responsibility of the permit holder who originally held the hatchlings to ensure that an appropriate facility will hold the turtles until they reach the minimum size for release. If loggerheads held for educational display are to be released, the release location must be approved in advance by the FWC.

Note that federal law (CFR 17.21(c)(3)) does not allow for any marine turtle listed as endangered to be held solely for educational display (in Florida this includes green turtles, leatherbacks, hawksbills, and Kemp's ridleys).

Any educational turtle that is injured or dies in captivity must be reported to FWC immediately. Educational turtles that die in captivity must be necropsied fresh (not frozen) to determine the cause of death. For additional information on conducting necropsies please refer to the necropsy requirements on page 4-8.

HOLDING NON-RELEASABLE TURTLES

Some animals sustain injuries that preclude their ability to survive in the wild. One example of this would be permanent blindness. Each individual must be evaluated on a case-by-case basis. The evaluation must take into account the condition of the individual at the time of stranding, including whether or not certain injuries were already healed and appear unrelated to the current stranding event.

There are also animals in captivity whose genetic identity does not match that of the wild populations found in Florida or whose genetic origin is unknown. These are generally animals that were brought into Florida from other countries many years ago for research purposes or animals that have been transferred from an out-of-state facility that originally obtained the animal from another region of the world. Because these animals come from a different genetic stock(s), they may not be released into Florida waters.

Any non-releasable turtle that is injured or dies in captivity must be reported to FWC immediately. Non-releasable turtles that die in captivity must be necropsied fresh (not frozen) to determine the

cause of death. For additional information on conducting necropsies please refer to the necropsy requirements on page 4-8.

HOLDING TURTLES FOR REHABILITATION

A facility whose permit authorizes them to hold marine turtles for rehabilitation may receive any marine turtle that is sick or injured for treatment or rehabilitation. Upon receiving a sick or injured marine turtle, the attending veterinarian shall examine the turtle within 24 hours. If this is not possible, immediate arrangements shall be made with the FWC to move the turtle to another facility. Facilities must notify the FWC within four days of receiving a turtle for rehabilitation (even if the turtle dies). Also, a short assessment of the progress of each turtle undergoing rehabilitation is to accompany the holding facility quarterly report for every quarter that turtle is kept. Guidelines for releasing rehabilitated turtles are on page 4-6.

Turtles held for rehabilitation should be isolated from other turtles whenever possible. The water from tanks used for rehabilitation may not flow into tanks holding other marine turtles unless it is appropriately treated (e.g., chlorination, ozonation, etc.). Isolation of rehabilitating turtles is vital to prevent the spread of diseases.

Turtles with fibropapillomatosis (FP) must be isolated from turtles that are not known to have the disease. The high incidence of FP in green turtles in Florida waters is of special concern. Research is in progress but the cause of this disease remains undetermined. These growths are highly vascular when large and appear to be extremely sensitive due to the presence of nerve bundles, especially around the eyes. Only the most experienced veterinary personnel should be treating these individuals.

Any rehabilitating turtle that dies in captivity must be necropsied as soon as possible to determine the cause of death. For additional information on conducting necropsies please refer to the necropsy requirements on page 4-8.

HOLDING TURTLES FOR RESEARCH

An investigator may be authorized to hold turtles for scientific research. This authorization is granted only after a research proposal has been submitted by the investigator and approved by FWC. Unless a specific exception is granted because of research conditions, anyone holding turtles for scientific research shall follow all the guidelines for holding turtles (i.e., general tank size and water quality standards must be adhered to). Additional requirements for holding research turtles may be imposed, depending on the nature of the research.

Research that could result in the death of an endangered marine turtle (all species except loggerheads) requires a federal U.S. Fish and Wildlife Service (USFWS) permit (in addition to the FWC permit). A USFWS permit is also required for research utilizing any endangered marine turtle (all species except loggerheads) that will be held for more than 45 consecutive days.

Any turtle that is injured or dies while being held for research purposes must be reported to FWC immediately. Research turtles that die must be necropsied fresh (not frozen) to determine the cause of death. For additional information on conducting necropsies, please refer to the necropsy requirements on page 4-8.

HOLDING TANK REQUIREMENTS

Tank Size:

Holding tank sizes for turtles shall be based upon the size of the largest specimen in the tank as described below. Use straight carapace measurements to determine the appropriate tank size (Figure 4-1).

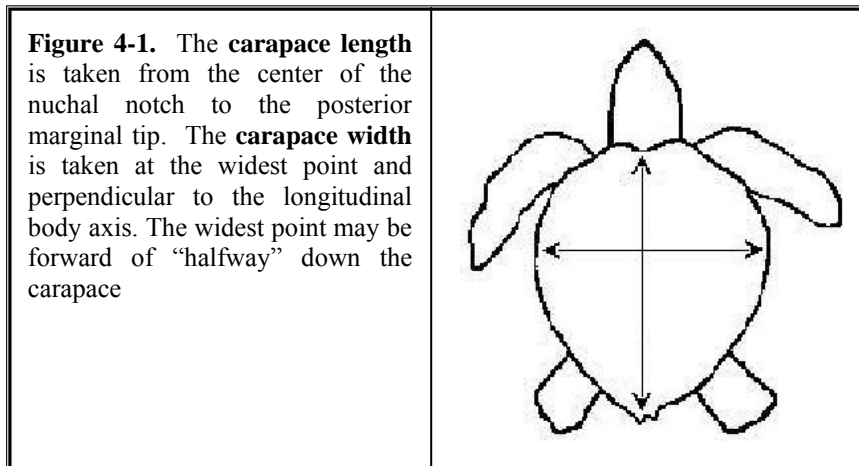

1. Hatchlings and Post-hatchlings (up to 10 centimeters straight carapace length) – for one hatchling, a tank with a surface area of at least five times the shell length, by two times the shell width of the turtle plus minimum water depth of one foot. For each additional hatchling or post-hatchling, increase the original surface area by 25%.
2. Turtles up to 50 centimeters straight carapace length – for one turtle, a tank with a surface area of at least seven times the shell length, by two times the shell width of the turtle plus a minimum water depth of two and a half feet. For each additional turtle, increase the original surface area by 50%.
3. Turtles up to 65 centimeters straight carapace length – for one turtle, a tank with a surface area of at least seven times the shell length, by two times the shell width of the turtle plus a minimum water depth of three feet. For each additional turtle, increase the original surface area by 50%.
4. Turtles with a curved straight length greater than 65 centimeters – for one turtle, a tank with a surface area of at least nine times the shell length, by two times the shell width of the turtle plus a minimum water depth of four feet. For each additional turtle, increase the original surface area by 100%.

- TIP #1: 3 foot diameter tank = 7 square feet of surface area
 6 foot diameter tank = 28 square feet of surface area
 9 foot diameter tank = 64 square feet of surface area
 12 foot diameter tank = 113 square feet of surface area
- TIP #2: 10 cm straight carapace length needs a tank with ≥ 1 square foot of surface area
 45 cm straight carapace length needs a tank with ≥ 25 square feet of surface area
 50 cm straight carapace length needs a tank with ≥ 31 square feet of surface area
 65 cm straight carapace length needs a tank with ≥ 51 square feet of surface area
 90 cm straight carapace length needs a tank with ≥ 123 square feet of surface area

NOTE: Turtles housed together must be prevented from injuring each other.

Exceptions:

1. Sick and/or injured turtles may be held in smaller isolation tanks to facilitate medical treatment. Any turtles held for this purpose must be protected from desiccation and moved to an appropriate tank as soon as health allows.
2. Tanks holding mobility-impaired turtles shall meet the standard size requirements, unless it can be demonstrated that the tank is detrimental to the health or welfare of the animal. In such cases, written documentation by a veterinarian confirming the need for such exemption shall be maintained by the permit holder and made available upon request by FWC.
3. If necessary, healthy turtles may be held in tanks with dimensions less than those required for no more than one week every three months or as approved after consultation with FWC. Those tanks must be large enough to allow complete submergence and unimpeded turning.

Tank Condition:

1. The inside surfaces of holding tanks must be free of toxic substances such as lead or copper paints.
2. Holding tanks shall not contain any non-food items that could be ingested by a turtle. Turtles will attempt to eat just about anything. Be sure that nothing except intended food is put into or falls into a turtle tank; this includes material that could be either ingested immediately or broken apart and ingested.
3. Holding tanks shall not contain entangling materials. If there are rocks, ledges, or other structures in the tank, position them such that a turtle cannot become tightly wedged or trapped underwater.
4. The drains and intake pipes of holding tanks shall be constructed or securely shielded such that a turtle cannot become trapped and be held underwater by them.
5. All the tanks in which marine turtles are housed shall have enough lighting (sunlight and/or artificial lighting) to allow for easy viewing of the animals in all areas of the tank. The

photoperiod of captive marine turtles shall be similar to a natural photoperiod. Tanks may not be artificially illuminated for more than sixteen hours per twenty-four hour period.

WATER QUALITY AND FEEDING STANDARDS

Water Quality/Quantity:

1. The salinity shall be maintained between 20 ppt and 35 ppt. If necessary, marine turtles may be maintained in less saline water for up to 24 hours per week. Turtles undergoing medical treatment may be kept at salinity's above or below this range as prescribed by the attending veterinarian.
2. Water pH shall be maintained between 7.5 and 8.5.
3. Water temperatures shall be maintained between 20°C and 30°C (68°F - 86°F). The use of shades on outdoor tanks will help prevent tank water temperatures from becoming too warm. At facilities where tank water temperatures drop below 20°C (68°F), heating units shall be utilized to maintain acceptable temperatures.
4. If chlorine (or bromine) is used to treat the water, free chlorine levels should be maintained no higher than 1.0 PPM and no lower than 0.5 PPM (depending on the species and its sensitivity to chlorine).
5. Coliform bacteria (MPN) must not exceed 1000/100ml of water, according to Animal and Plant Health Inspection Service (APHIS) regulation 9 CFR 3.106(b). FWC may, at any time, request a coliform count from a facility holding marine turtles. If steps are taken to prevent the conditions in which coliform bacteria proliferate, and there are no chronic health problems as determined by FWC, then a facility may be exempted from routine coliform tests. The aforementioned steps include adequate filtration (removing suspended material and larger pieces of feces and leftover food) and the use of an appropriate sanitizing chemical such as chlorine, or a high turnover rate with fresh, uncontaminated seawater. If acceptable coliform levels [as identified above] are exceeded, steps must be taken to reduce levels per the APHIS recommendations for sterilization of marine mammal pool waters¹.
6. Unless a turtle is being treated with a substance that inadvertently reduces clarity (e.g., the use of mineral oil as part of medical treatment) the water shall be clear enough to allow viewing of marine turtles in any part of the tank.
7. No chemical may be used to treat water in a tank housing marine turtles if the chemical is not safely ingestible by the animals at the dilution required for effective treatment.
8. Any facility housing marine turtles shall have the ability to provide adequate water quantity under normal and emergency conditions. In an emergency, marine turtles may be kept out of water for a maximum of four hours per week (longer periods are acceptable when directed by the veterinarian for health reasons). During this time, the animal shall be kept in a temperature

¹ Spotte, Stephen. 1991. *Sterilization of Marine Mammal Pool Waters: Theoretical and Health Concerns*. U.S. Department of Agriculture, Animal and Plant Health Inspection Service Technical Bulletin No. 1797.

controlled environment to ensure that its core temperature is not chilled or heated. It should also be protected from drying out and physical damage. Dry-docking turtles should occur only very rarely, if ever. If marine turtle tanks are regularly drained and cleaned, adequate back up holding tanks must be available to house the turtles during this time.

9. Water disposal shall be in accordance with all applicable local, state, and federal regulations.

Feeding:

1. Food shall be provided in an unspoiled and uncontaminated condition. Food should either be fresh, flash frozen and glazed, or frozen in some other manner that ensures the quality of the food. Any frozen food is to be completely thawed in cool water or in air in refrigerated coolers prior to feeding and used entirely or discarded. Frozen food that has been thawed shall be used within 24 hours after thawing. Under no circumstances may food be refrozen. If the quality of the food is questionable, it shall not be used for marine turtle feeding. Reference the APHIS marine mammal food handling guidelines for further information².
2. Food shall be of a type and quantity that meets the nutritional requirements for the particular species. Reasonable efforts shall be made by the holding facility to develop proper diets for marine turtles. It is the responsibility of the holding facility to ensure and justify the adequacy of its feeding regimen.
3. Hand feeding of turtles that will eventually be released is prohibited except when absolutely necessary for rehabilitation. In the latter case, the turtle should be allowed to feed on its own as soon as possible.
4. Whenever possible, release candidates should be fed live food prior to release to observe foraging behavior.

VETERINARY CARE

All facilities housing marine turtles must have the assistance of a licensed veterinarian trained and experienced in herpetological medicine. Facilities shall also have the assistance of a back-up veterinarian trained in the care of marine turtles whenever the primary veterinarian is unavailable. The names of the both the primary and back-up veterinarians shall appear on the facility's permit.

TRANSPORTING LIVE TURTLES

If you need to transport a sick or injured marine turtle, it must be shaded and otherwise protected from extremes of heat and cold (not above 90°F and not below 50°F). If a turtle is transported at temperatures greater than or equal to 75°F, it should be cooled by keeping a wet towel on the carapace and by periodically pouring water over the head. Water and wet towels should not be used

² Crissey, Susan D. 1998. *Handling Fish Fed to Fish-Eating Animals: A Manual of Standard Operating Procedures*. U.S. Department of Agriculture, Agricultural Research Service, National Agricultural Library.

when transporting turtles at temperatures less than 75°F or at any time they are exposed to an air-conditioned environment. The only exception is that any open wounds should be kept moist with clean freshwater. At temperatures less than 75°F, turtles may be kept from drying out during transport by applying a thin layer of petroleum jelly (e.g., Vaseline®) to the carapace and all the soft tissues (except the eyes and any open wounds). The use of petroleum jelly is recommended only for small turtles (juveniles).

FWC stranding staff will often suggest the use of towels, water, or petroleum jelly when making transportation arrangements for each live turtle. The table below provides guidance in determining which treatment is most appropriate for any live turtle needing transport.

Ambient Air Temperature around Turtle	Duration of Transport (hours)	Barnacles or Other Epibionts present on carapace	Turtle Class Size	Recommended Treatment
75°F (or warmer)	Any	--	Any size	Wet towel or water mist
74°F (or cooler)	≤2 hours	--	Any size	Dry towel
74°F (or cooler)	≥2 hours	Carapace clear	Juvenile	Petroleum jelly
74°F (or cooler)	≥2 hours	Carapace clear	Sub-adult/Adult	Dry towel
74°F (or cooler)	≥2 hours	Large amounts of epibionts present	Any size	Dry towel

Any containers housing turtles during transport are to be padded and may not contain any material that could be accidentally ingested. Hatchlings and post-hatchlings should be transported in a container with moist sand; they should not be transported in water. The containers should be secured during transport such that they do not slide around or tip over.

RELEASE OF REHABILITATED TURTLES

The goals of the Endangered Species Act (ESA) and the Marine Turtle Program of the FWC are to conserve and recover wild populations of threatened and endangered species. Species are listed under the ESA only after it has been determined that they are threatened or endangered with extinction. It is therefore imperative that as many individuals as possible are available to the wild population to mature and become part of the breeding population. Furthermore, a cooperative agreement under section 6 of the ESA between the USFWS and FWC, as in accordance with the Code of Federal Regulations, only allows FWC to remove endangered marine turtles from the wild if such action is necessary to aid sick or injured animals. It prohibits the holding of healthy endangered turtles in captivity for a period of more than 45 consecutive days. Therefore, endangered turtles must be released when their health status has improved to a point where they can be expected to survive in the wild. Many injuries, when healed, will not hamper a turtle's existence in the wild. For example, the loss of a flipper does not prevent a turtle's ability to survive in the wild. Flipper damage is not an unusual occurrence and is often documented on nesting beaches.

FWC staff shall determine the appropriate timing and location for release of a turtle that has been held for educational purposes or held illegally (e.g., held in a home aquarium). Not all size classes

occur in Florida waters; therefore individual size must be considered to determine an appropriate release location. For example, once leaving the beach hatchling loggerhead turtles spend a period of years drifting in a pelagic environment around convergence zones and gyre systems. Loggerhead turtles are not normally observed in Florida's nearshore/inshore waters until they reach 45 cm straight-line carapace length (SLCL) (Foley, STSSN). It appears that hawksbill and green turtles, on the other hand, move back into nearshore waters at a much smaller size. Hawksbills of all size classes occur in Florida waters including the very small pelagic size. Hawksbill turtles residing in Florida waters have been observed around nearshore reef sites off the southeast coast of Florida in the 20-30 cm SLCL size class (Meylan, personal communication). Green turtles are observed in nearshore and inshore waters off of the central east coast of Florida as small as 21 to 25 centimeters SLCL (personal communication with D. Bagley and M. Bresette). In Florida Bay, the smallest green turtles observed are ~28 cm SLCL (Schroeder, personal communication).

The final determination of an individual's fitness for survival in the wild will be made through FWC marine turtle biologist staff consultations with the facility's veterinarian, animal care personnel, and other persons with marine turtle expertise, as necessary. When a facility's veterinarian has determined that an animal has recovered sufficiently from its illness or injury and is ready for release, the principal permit holder, or a designee, shall contact FWC staff in Tequesta to discuss the appropriate time and site for the release. All marine turtles shall be measured, weighed and tagged (if size appropriate) prior to release (see Section 5 on tagging turtles). Release forms must be completed (this includes tagged and non-tagged animals, except hatchlings) and submitted with the quarterly report for all turtles released.

Note on release of turtles with fibropapillomas (FP): Turtles with FP shall be retained for a minimum of one year after the last observance of a tumor is noted and removed, unless specifically approved for early release by FWC.

NECROPSY REQUIREMENTS FOR TURTLES THAT DIE IN CAPTIVITY

Necropsies shall be performed on any turtles that die at a holding facility, including turtles held for rehabilitation, non-releasable turtles, and turtles held for education or research. Necropsies shall be performed by the attending veterinarian or by FWC staff. Minimally, necropsy procedures are to follow the techniques set forth in the Sea Turtle Necropsy Manual (Wolke and George, 1981). The original necropsy report is to be submitted with the holding facility's quarterly report. If a non-releasable turtle dies or a turtle held for educational display or research, all efforts shall be made to determine the cause of death in order to help prevent future loss. Investigation into the cause of death should include a **complete** histopathological examination.

Note: Before conducting necropsies on any stranded turtles that die within a week after arriving at a facility, the permit holder must notify the State's marine turtle stranding coordinators in either Jacksonville or Tequesta.

DISPOSITION OF DEAD TURTLES

Following necropsy the carcass of any marine turtle that dies, while in the custody of an FWC permitted facility, shall be completely destroyed (in accordance with state and local laws) or, subject to the approval of FWC, be offered to a museum, university, or other educational or research facility. **Under NO circumstances may a dead marine turtle, or any part thereof, be salvaged for any purpose other than FWC approved education and/or research activities.**

FACILITY INSPECTIONS

In order to ensure that facilities holding live marine turtles for rehabilitation, education, and/or research are maintaining the standards for care and maintenance, and that all applicable laws, rules, and guidelines are complied with, all facilities are subject to inspection at any time by commission personnel. Prior to issuance of a permit, new facilities applying for a permit to hold live marine turtles for rehabilitation, education, and/or research, shall be subject to inspection by commission personnel. All facilities being inspected should be fully operational for a minimum of two weeks prior to the date of inspection in order to ensure that water quality and filtration components are working properly. Facilities may be asked to provide a current coliform bacteria count and water quality data upon inspection. Facilities will be provided with a copy of the report generated from the inspection.

QUARTERLY AND ANNUAL REPORTING REQUIREMENTS

All permit holders authorized to hold marine turtles for any reason are required to submit a quarterly report on forms provided by FWC. For each turtle held, the permit holder shall report the turtle's state identification number, the species, the date acquired, the stranding ID (if applicable), and the turtle's current size and status. A state identification number (SID) is provided for every turtle held in captivity. The SID number is issued out of the Tequesta Office. Turtles that are transferred from one Florida facility to another should have received a SID number at the first facility receiving the turtle. The SID number is transferred, via a Marine Turtle Transfer Form (Appendix A), with the turtle to the facility taking over the care of the animal. Each time a facility receives a turtle [excepting hatchlings and turtles that are transferred as described above], the permit holder shall contact the FWC Tequesta office to obtain a SID number for the animal. If you receive an animal but are unable to reach turtle staff in Tequesta (e.g., if calling after regular work hours or during a weekend), leave a message and a turtle staff person will get back with you and provide you with a SID number for the turtle.

Under status, the permit holder shall identify the current status of each turtle using the status code list on the reporting form. In the water quality section, the permit holder shall report the weekly temperature, salinity, and pH values for the water in which the turtles are held.

Quarterly and annual reports shall be submitted to FWC's Tequesta office (Imperiled Species Management, Tequesta Field Station, 19100 SE Federal Highway, Tequesta, Florida, 33469). **Reports are due as follows:**

1st quarter report due by no later than April 15th (January – March activities)

2nd quarter report due by no later than July 15th (April – June activities)

3rd quarter report due by no later than October 15th (July – September activities)

4th quarter report due by no later than January 15th (October – December activities)

The annual report is due by no later than January 31st (and should include a January through December summary). Quarterly reports shall include copies of STSSN forms (for live strandings received), transfer forms, tag/release forms, papilloma forms, and necropsy forms as applicable during the reporting period. In addition, an annual (calendar year) report is required that includes: the SID number, tag numbers (if tagged), species, sex (if known), acquisition date, purpose of acquisition, disposition date, and measurements at disposition.

EDUCATIONAL PRESENTATIONS USING LIVE MARINE TURTLES

SUMMARY

This section is specifically intended for those persons whose permit authorizes them to **use live marine turtles in educational presentations, or hold loggerheads for educational display.** These personnel are also authorized to:

- **transport or transfer turtles within Florida**

Personnel are not authorized to conduct the following activities without explicit permission from FWC:

- **transport or transfer turtles into or out of Florida**

ACTIVITY DESCRIPTION

The following guidelines shall be followed regarding the use of live marine turtles in educational presentations. The phrase "educational presentation" refers only to the use of turtles away from the approved captive facility (e.g., at schools, festivals, fairs, etc). These guidelines have been developed by the FWC in consultation with the U.S. Fish and Wildlife Service and have been specifically designed to minimize the stress experienced by turtles used for educational presentations.

1. No turtle shall be used in an educational presentation unless its health will not be compromised by this activity. No underweight or weak turtles are to be used.
2. Whenever possible, a loggerhead is to be used. A rehabilitating green turtle may be substituted if a loggerhead is not available. Rehabilitating Kemp's ridleys and hawksbills may not be used. Release of a rehabilitated turtle may not be delayed because of potential use in an educational presentation. All rehabilitating turtles are to be released as soon as their health status improves to the point where they can be expected to survive in the wild.
3. During periods away from the captive facility (except during transport when the turtle should not be held in water), the turtle is to be kept in a container of clean salt water. This container shall be large enough to allow the turtle to turn completely around (360°) and filled with enough clean salt water to allow complete submergence of the turtle.
4. The longest period of time a turtle may be kept away from the captive facility (for use in an educational presentation) is twelve hours. All turtles are to be returned to the facility within this time period.

REPORTING REQUIREMENTS

Facilities using marine turtles in educational presentations must submit an annual report on the *Educational Presentations* form (Appendix A).

DIVE/SNORKEL PROGRAMS IN TANKS HOLDING MARINE TURTLES

SUMMARY

This section is specifically intended for those persons whose permit authorizes them to **conduct dive/snorkel programs in tanks holding marine turtles**.

ACTIVITY DESCRIPTION

The following guidelines shall be followed regarding programs that allow persons from the public to SCUBA dive and/or snorkel in tanks where marine turtles are held. These guidelines are specifically designed to minimize stress that may occur to marine turtles kept in tanks where dive/snorkel programs are authorized. These guidelines also provide instruction to minimize potential harm to persons participating in dive/snorkel programs. Please note that the State of Florida does not accept any liability for unpredictable behavior by marine turtles that may result in injury to participants.

The permitted facility shall ensure the following activities are strictly enforced:

1. Feeding, touching and/or handling turtles by dive/snorkel program participants is strictly prohibited.
2. Turtles undergoing rehabilitation shall not be placed in tanks where dive/snorkel programs are conducted.
3. All dive/snorkel programs shall be closely monitored by facility staff; at least one staff member must be in the tank with participants at all times.
4. Any participant observed harassing a turtle shall be required to exit the tank immediately.

Participants shall be informed of the following information:

1. All species of marine turtles are protected under State and Federal laws. Under the Endangered Species Act, it is illegal to “harass, harm, pursue, hunt, shoot, wound, kill, trap, capture, or collect... any marine turtle or its nest at any time”.
2. The Florida Fish and Wildlife Conservation Commission permits facilities to hold marine turtles for education, research and/or rehabilitation purposes.
3. Marine turtles (captive or wild) should never be approached. Marine turtles are very mobile under water; they are powerful creatures and can cause serious injury. Nesting turtles can be easily disturbed and provoked to return to the ocean without nesting. It is illegal and potentially dangerous to attempt to interact with them.

REPORTING REQUIREMENTS

Any injury to persons resulting from participation in a dive/snorkel program shall be reported to the FWC, Imperiled Species Management section immediately.

SECTION 5 - TAGGING MARINE TURTLES

Summary

This section is specifically intended for those persons whose permit authorizes them to:

- **tag turtles using external flipper tags**
- **tag turtles using PIT tags**

Personnel are not authorized to conduct the following activities unless specifically stated on the permit:

- **hold or capture turtles**
- **transfer or transport turtles into or out of Florida**

ACTIVITY DESCRIPTION

Tags are available from the Cooperative Marine Turtle Tagging Program (CMTTP), a centralized tagging program developed to distribute tags, manage tagging data, and facilitate exchange of tag information managed by the Archie Carr Center for Sea Turtle Research (ACCSTR) at the University of Florida. This program is funded by the National Marine Fisheries Service Southeast Fisheries Science Center (NMFS/SEFSC) (<http://accstr.ufl.edu/cmtp.html>).

HANDLING AND FLIPPER TAGGING TURTLES

1. Handling and tagging turtles can result in introduction or transmission of disease among turtles. Use appropriate techniques and disinfectants to avoid harming the turtles. Identify the area where the tag will be applied and swab this area with antiseptic. All tagging equipment must be sterilized prior to use.
2. When tagging turtles on nesting beaches, wait until the turtle has completed egg-laying before tagging or measuring the turtle.
3. Tags should be cleaned of the oily residue from manufacturing in hot soapy water, rinsed or soaked in alcohol, and stored in sealed plastic bags until used.
4. Due to tag loss, double tagging (one tag on each of two flippers) is now standard procedure. Place the tag within the molded surface of the applicator, and attach the tag to the trailing edge of the flipper. Attach the tag on the flipper so that it extends slightly from the edge of the flipper. On front flippers, the tagging site is the first or second large scale on the posterior edge of the flipper. Some researchers use the site proximal to and adjacent to the first large scale or between the two large scales. On hind flippers, the tagging site is the first large scale. Some researchers use the site proximal to and adjacent to the first large scale.

5. Once the tag has been attached, check the tip to be sure it has properly cinched. The tag tip should overlap the edge of the hole by at least 3 mm. If the overlap is insufficient, carefully fit the tag back into the applicator and apply greater pressure. If this is still unsatisfactory, remove and apply another tag. This is important; improperly cinched Inconel tags are shed quickly.
6. Fill out the appropriate tagging data form (see sample form in Appendix A; electronically generated copies are acceptable) and submit all completed forms as required with copies to FWC.
7. Do not tag stranded carcasses on the beach.
8. Maintain the tag applicators so they continue to function properly. They should be cleaned with a bleach-water solution after each use. The salt environment is very corrosive and frequent application of a light lubricant (e.g., WD40) to the spring and pivotal surface is necessary, particularly when storing for long periods between seasons. Be careful not to contaminate the tags with lubricant.

MEASURING MARINE TURTLES

1. Accurate and precise measurements are critical. Because a number of different measurements have been used in studies of sea turtles, it is essential to note specifically which measurements are recorded on the data sheets and which units are used (cm or inches; cm is the preferred unit).
2. Using calipers, measure the *straight carapace length notch to tip* (SCLn-t) from the anterior point at midline (nuchal scute) to the posterior tip of the supracaudals. Because the posterior tips of the supracaudals are frequently broken in juveniles or worn away in adults, *minimum straight carapace length* (SCLmin; also referred to as SCLnotch-notch) is measured from the anterior point at midline (nuchal scute) to the posterior notch at midline between the supracaudals.
3. In addition to the straight length, curved carapace length should also be measured with a flexible tape. Measure the *curved carapace length notch to tip* (CCLn-t) from the anterior point at midline (nuchal scute) to the posterior tip of the supracaudals. *Minimum curved carapace length* (CCLmin; also referred to as CCLnotch-notch) is measured from the anterior point at midline (nuchal scute) to the posterior notch at midline between the supracaudals. The CCLmin measurement should be obtained because the posterior tips of the supracaudals are frequently broken in juveniles or worn away in adults and because there is greater variability in CCLn-t as a result of the unpredictable way that the tape measure deviates from the midline.
4. Be sure to specify on the data form the method (straight or curved) and the measurement taken (SCLn-t or SCLmin or CCLn-t or CCLmin).

PIT TAGGING

Applying PIT tags is more invasive than applying flipper tags and should be done only under the guidance of workers experienced with the technique. The following procedure has been found to be safe and effective.

1. Prepare the sterile PIT tag needle with tag, plunger-applicator, PIT tag reader, and sterile gauze/cotton soaked with an antiseptic solution such as Betadine.
2. Identify the area where the tag will be applied and swab this area with antiseptic. One ideal application point is within the soft, fleshy area dorsal to the wrist bones of the front flipper.
3. Prepare to insert the needle at a seam between scales, at an acute angle (nearly parallel with the skin of the flipper), and with the needle directed proximally (toward the turtle). The point of the needle should be closest to the skin (the terminal opening of the needle should face upward).
4. Hold the flipper firmly (with assistance if necessary) so that the flipper cannot move and insert the tagging needle approximately $\frac{3}{4}$ inch and just beneath the skin. Use the plunger to insert the tag through the needle, place the cotton or gauze with antiseptic over the needle entry point, and withdraw the needle. Keep pressure on the needle entry point with the cotton or gauze for approximately one minute, or longer if bleeding occurs.
5. Swipe the PIT tag reader over the tagged flipper, record the tag number, swipe again, and verify the recorded number.

REPORTING REQUIREMENTS

Fill out the appropriate tagging data form (see sample form in Appendix A; electronically generated copies are acceptable) and submit all completed forms as required with copies to FWC (as mentioned above). A sticker with the PIT tag number accompanies the PIT tag; this sticker may be adhered to the tagging data form rather than handwriting the tag number.

SECTION 6 - RESEARCH ACTIVITIES

ACTIVITY DESCRIPTION

This section is specifically intended for persons approved to conduct research, as identified under the "Authorized Research Projects" section of the permit, or for persons requesting to conduct research. Investigators may only conduct activities that are specifically described in the approved research proposal. Modifications on any aspect of an approved research project require written approval from FWC.

Marine turtle research proposals are reviewed by FWC's marine turtle program staff as well as outside reviewers with expertise in the subject area. Researchers should submit their requests for new research at least 90 days prior to the proposed beginning of the project.

Any studies involving the sacrifice of live animals or eggs or that involve the holding of species listed as endangered under the Endangered Species Act in excess of 45 days also require a federal permit from the U.S. Fish and Wildlife Service (contact USFWS - Division of Endangered Species). The office is located in Atlanta, Georgia and can be reached at (404) 679-4176.

Any studies involving in-water research also requires a federal permit from the National Marine Fisheries Service (contact NMFS - Office of Protected Resources - Endangered Species Division). The Office is located in Silver Spring, Maryland and can be reached at (301) 713-1401. Information about endangered species permits can also be obtained via the NMFS web site at: <http://www.nmfs.noaa.gov/pr/permits/>.

When a NMFS permit is necessary for work that FWC is considering for a permit, FWC will allow a copy of the applicant's NMFS permit application to be substituted for the format given below. The applicant needs only to complete the NMFS permit application and provide FWC with a copy. FWC should also be copied on correspondence between NMFS and the applicant so that FWC may follow any concerns indicated by NMFS and how those concerns are resolved.

NEW RESEARCH PROJECTS

To request approval to conduct a research project, the principal investigator must submit a proposal to the Imperiled Species Management Section (ISM), 19100 SE Federal Highway, Tequesta, Florida 33469. Joint projects involving several investigators should be submitted as one proposal, with each component and the personnel involved in that component identified (a discussion of the project objectives should be done for the project as a whole, and specific experimental methods should be discussed by the investigators). The proposal must be detailed and specific and must include the following sections:

1. Title of the project.
2. Name of the principal investigator(s) and his/her qualifications and experience relative to the proposed research. Also include a list and relevant research experience for all personnel involved with the project, and a list of publications and grants pertinent to the specific project.

3. Identify whether the proposal is submitted as under-graduate thesis work, graduate thesis work, or other.
4. The date of the application.
5. Purpose/Justification – Identify how the proposed research will contribute to the recovery of marine turtle species in Florida, identifying specific tasks listed in the U.S. Fish and Wildlife Service Recovery plans where possible.
6. Objectives – Provide a short summary of the project, including an identification of the species involved, a brief overview of the methods to be utilized including the experimental design and statistics, and specific objectives or questions related to the Marine Turtle Recovery tasks to be answered by the proposed research.
7. Methodology – Provide a detailed description of the experimental methods, including number of replicates, experimental design, methods for capturing, handling, tagging, and/or holding marine turtles. This section must also include the maximum number and species of animals needed and their expected fate.
8. Justification for proposed methodology – Present possible alternative methodologies and explain justification for proposed methodology.
9. Time frame for the study.
10. Study site(s) – Identify the specific areas where the proposed work will be accomplished.
11. Literature citations.
12. If the requested research is not associated with a specific permit, the PI must also complete and submit a Marine Turtle Permit Application.

AMENDMENTS TO APPROVED PROJECTS

Requests for modifications to previously approved research projects should address all applicable sections listed above including a detailed description of the proposed changes.

REPORTING REQUIREMENTS

Annual Report(s): Renewal of an authorized research project is contingent upon receipt and approval of an annual report for each project. The annual report is due by the end of each calendar year and should be submitted with the permit renewal form. The following information should be included in the annual report for **each** project:

1. The title of the project [as it appears on the FWC marine turtle permit].
2. A detailed description of activities conducted, including the species and total number of animals collected/used, the manner of collection/use, and the dates and locations of collection/use.
3. Any preliminary analyses of the data.
4. A description of any problems and/or unforeseen effects which may have arisen during the research activities.
5. If mortality occurs, a brief narrative of the circumstances surrounding each injury or death and a description of the measures taken to correct the problem that caused the injury or death.
6. Steps that have been and will be taken to coordinate the research with that of other researchers.
7. An updated scope of work for the upcoming year(s). Please note that any requests for modifications to the research must be clearly identified.

Final Report(s): Within ninety (90) days of completion of the project the permit holder must submit three (3) copies of the final report to ISM (in Tequesta) summarizing the results and success of the research relative to its goals. The final report should have a title that matches the original title in the proposal, and sections for introduction, methods, results, discussion, and literature cited.

SECTION 7 - EDUCATIONAL ACTIVITIES

PUBLIC AWARENESS TURTLE WATCHES

SUMMARY

This section is specifically intended for those persons whose permit authorizes them to **conduct public awareness turtle watches**.

ACTIVITY DESCRIPTION

The following conditions must be followed:

1. Only one permitted organization may conduct watches in any one area. The watch location must be approved by the FWC prior to the first watch of the season.
2. All participants in turtle watches must be informed of the federal and state laws protecting marine turtles and their nests. Participants must be informed that conducting turtle watches, touching marine turtles, and handling marine turtle eggs without a permit is unlawful.
3. Turtle watches may only be conducted with loggerhead turtles. Should any other species be encountered on the nesting beach, the group is not to be guided near that turtle.
4. Interpretive programs (lectures, slide presentations, etc.) that incorporate accurate, updated information on marine turtle conservation and biology are mandatory. Programs should be presented prior to the actual watch and must include an explanation of procedures to be followed during the experience. If desired, FWC staff members will assist in developing interpretive programs. A list of current topics that should be discussed during the presentation is listed below.
5. Group size must not exceed 25 participants per guide; total group size must not exceed 50 individuals. All guides and scouts must be thoroughly trained and listed on the Marine Turtle Permit issued by the FWC.
6. Public awareness turtle watches may neither be commercialized (conducted for profit) nor exploited for commercial endeavors. Fees may only be charged by non-profit organizations to cover legitimate costs incurred in marine turtle conservation efforts. Do not accept reservations made by commercial enterprises that may charge a fee for services. Please remember that if you charge a fee you may be subject to litigation and should carry liability insurance.
7. Age limitations for participants are left to the discretion of the principal permit holder.
8. Scouts shall be used to search for a nesting loggerhead unless the total group size does not exceed five persons. If an all terrain vehicle (ATV) is used for scouting, a red filter shall be placed over the headlight(s). The headlight(s) may only be used if absolutely necessary, and the ATV is to be operated at the waters' edge. Drive slowly and watch for hatchlings.

9. The use of flashlights by participants is not permitted. The use of low intensity flashlights with a red filter is limited to the walk leader and permitted scouts only. Leaders and scouts may not use flashlights while scouting for a turtle or while guiding participants to the nesting site. A flashlight may only be used to ensure safety while gaining access to the beach. After approaching the turtle, one light may be used by the group leader or a scout to illuminate the egg chamber such that participants can observe egg deposition. The light may not be used to illuminate the turtle until after covering is underway. Remember that other turtles are in the area and hatchlings may be emerging nearby. Improper use of light can deter other nesting females and disorient emergent hatchlings.
10. Turtle-watch leaders and scouts are encouraged to invite persons who are on their own looking for turtles to join the group. This is an opportunity to educate persons who might otherwise disturb nesting turtles.
11. To avoid disturbing the turtle, the leader or scout must exercise great caution when exposing the nest. This is to be conducted prior to the group's arrival near the nesting turtle. At no time should sand be allowed to fall into the nest chamber.
12. Participants must be instructed to stay with the group and remain quiet at all times. During the entire watch, the group must remain together. The group may not approach the turtle until egg deposition is well underway. Participants, scouts, and the leader must approach from the rear and remain behind the nesting turtle during egg deposition. Scouts are responsible for keeping participants behind the turtle. Eggs may NOT be removed from the nest.
13. Contact (light touching) with the nesting female is permitted only after all eggs have been deposited and the turtle is on her way back to the ocean. Contact must not impede the turtle's return to the ocean.
14. The use of flash photography and lights [other than infrared] for filming is not permitted.
15. Only one nesting turtle is to be observed by the group each night.
16. No more than five turtle watches per seven-day week may be conducted in the selected beach area. If more than three watches per week are conducted, then two of the watches must be conducted on Friday and Saturday nights when there are more people on the beach. Extra scouts should be used on weekend nights, when more people on the beach are expected to be encountered and “picked up.” The FWC may further limit turtle-watch activities in certain areas because of the sensitivity of the area or because of permitted research activities that may be disturbed by the watches.
17. Turtle watches shall be conducted during June and July (peak of loggerhead nesting season) unless otherwise authorized by FWC in order to increase the potential for groups to encounter a nesting female. In certain cases, FWC may authorize turtle watches to occur during the later portion of May in order to meet public demand.

Current Issues To Discuss During Public Turtle Watch Presentations:

- Coastal development impacts
- Beach nourishment (pros and cons)
- Beachfront lighting impacts
- Marine debris impacts
- Poaching
- Natural and exotic predators
- Propeller/boat injury impacts
- Beach armoring impacts
- TEDs (Turtle Excluder Devices) and the shrimp fishery
- Impacts by other fisheries (gill net, longline,...)
- Impacts caused by human nighttime activity on the beach
- Archie Carr National Wildlife Refuge
- Non-nesting turtles (false crawls)
- International trade (CITES)
- Fibropapillomas
- FWC's non-manipulation or "hands off" management strategy
- Significance of Florida's nesting population

REPORTING REQUIREMENTS

A schedule of planned watches is to be completed on the turtle watch schedule form (Appendix A) and submitted to the FWC (Tequesta office) prior to the first scheduled watch for the season and no later than May 25th. In addition, a summary of each watch is to be completed on the turtle watch summary form (Appendix A) and submitted after the last watch of the season is conducted.

NIGHTTIME PUBLIC HATCHLING RELEASES

SUMMARY

This section is specifically intended for those persons whose permit authorizes them to **conduct night public hatchling releases**.

Personnel are not authorized to conduct the following activities unless specifically stated on their permit or unless otherwise approved in writing by FWC:

- **conduct nesting surveys**
- **relocate nests**
- **protect nests with self-releasing screen/cage**
- **protect nests with restraining cage**
- **use self-releasing hatchery**
- **use restraining hatchery**
- **excavate a nest prior to 70 days after the date of egg deposition (80 days in the case of a leatherback nest) or 72 hours after the first signs of emergence, whichever occurs first**
- **hold hatchlings recovered from nests in water**
- **use lights to lead the hatchlings to the water**

ACTIVITY DESCRIPTION

This activity applies principally to permit holders who utilize restraining beach hatcheries or cages. Under natural conditions, marine turtle hatchlings emerge in darkness. Although rain or overcast skies can induce daylight emergences, the overwhelming majority of hatchlings emerge in the dark. Except for releasing small numbers of hatchlings that are found disoriented or at the bottom of nests during nest success evaluations, daylight releases of hatchlings are not permitted. The following conditions must be adhered to when conducting nighttime public hatchling releases:

1. All participants must be informed of the State and Federal laws protecting marine turtles and their nests. Participants must be informed that conducting hatchling releases without a permit is unlawful.
2. Interpretive programs (lectures, slide presentations, etc.), which incorporate accurate, updated information on marine turtle conservation and biology, are mandatory. Programs should be presented prior to the hatchling release and must include an explanation of procedures to be followed during the experience. If desired, FWC staff will provide assistance in developing interpretive programs.
3. Healthy hatchlings are to be released on the night they emerge and allowed to crawl to the water on their own. Weaker hatchlings may be held on moist sand for 1-2 days until they are ready for release. If, after 1-2 days, the hatchlings are still not ready for release they should be transported to an FWC-permitted rehabilitation facility. Only permitted personnel may handle hatchlings.
4. Nighttime public hatchling releases may not be conducted at dusk or at dawn as these are time periods when predatory birds and fish are particularly active.

5. Flashlights or other artificial lights may not be utilized during releases. This applies to any members of the public observing such releases, as well as all permitted personnel involved in the release. A quick check of the release area with a flashlight fitted with a red filter, a short time after release will insure that all hatchlings have reached the water. Occasionally, individual hatchlings may need assistance in reaching the water. In such cases, they may be moved closer to the water's edge or placed in the shallows and allowed to swim off on their own.
6. The use of flash photography and/or lights for filming [other than infrared] is not permitted.
7. Hatchling releases may neither be commercialized (conducted for profit) nor exploited for commercial endeavors. Fees may only be charged by non-profit organizations to cover legitimate costs incurred in marine turtle conservation efforts. Do not accept reservations made by commercial enterprises that may charge a fee for their services. Please be reminded that if you charge a fee you may be subject to litigation and should carry liability insurance.
8. Age limitations for participants are left to the discretion of the principal permit holder.

REPORTING REQUIREMENTS

The principal permit holder shall report the number of public hatchling releases held each year on the Public Hatchling Release Form (Appendix A). If any problems were encountered during releases (e.g. hatchlings becoming disoriented during the release), please explain. The hatchling release form is to be submitted annually with the marine turtle permit renewal application.

MAINTAIN AND DISPLAY PRESERVED SPECIMENS

SUMMARY

This section is specifically intended for those persons whose permit authorizes them to **maintain and display preserved specimens**. These personnel are also authorized to:

- **transport or transfer preserved specimens within Florida**

Personnel are not authorized to conduct the following activities without explicit permission from FWC:

- **transport or transfer preserved specimens into or out of Florida**

ACTIVITY DESCRIPTION

This activity covers museums and educational facilities and allows the permit holder to maintain and/or display whole preserved marine turtles or marine turtle body parts for educational or scientific research purposes. Specimens displayed for educational purposes are to be accompanied by appropriate interpretive verbiage. Specimens may not be maintained for strictly decorative purposes. You are not authorized to import/export turtles or turtle parts outside the state of Florida (foreign or domestic) without prior written approval from FWC.

REPORTING REQUIREMENTS

Each principal permit holder is expected to keep a written inventory of all preserved specimens. FWC may ask for a copy of this list at any time. Annual reporting is not required.



APPENDIX A – FORMS, ETC.

-
- Beach Restoration Project Monitoring table
 - Captive Facility Report forms
 - Educational Presentation Using Live Turtles form
 - Lighting Disorientation form
 - Necropsy form
 - Nighttime Public Hatchling Release form
 - Papilloma form
 - Public Turtle Watch Schedule
 - Public Turtle Watch Summary
 - Stranding and Salvage form
 - Tagging Data form
 - Marine Turtle Transfer form

Marine Turtle Monitoring for Beach Restoration Projects

The following monitoring is required if you are conducting nesting survey for a beach restoration project. Reports summarizing the nesting should be submitted to the Tequesta office with a copy to the Tallahassee office by January 15 of the subsequent year. Data for nesting activity on the project beach and on 100 feet of beach immediately north and south of the project shall be reported separately, and should include numbers of nests lost to erosion or washed out. Summaries of nesting activity shall be submitted in electronic format (Excel spreadsheets).

Characteristic	Parameter	Measurement	Variable
Nesting Success	False crawls - number	Visual assessment of all false crawls	Number and location of false crawls in fill areas, groin areas, and nonfill areas: any interaction of the turtle with obstructions, such as groins, seawalls, or scarps, should be noted.
	False crawl - type	Categorization of the stage at which nesting was abandoned	Number in each of the following categories: emergence-no digging, preliminary body pit, abandoned egg chamber
	Nests	Number	The number of marine turtle nests in filled and nonfilled areas should be noted. If possible, the location of all marine turtle nests shall be marked on map of project, and approximate distance to the groins, sea walls or scarps measured using a meter tape (optional). Any abnormal cavity morphologies should be reported as well as whether the turtle touched groins, seawalls, or scarps during nest excavation
		Lost Nests	The number of nests lost to inundation, erosion or the number with lost markers that could not be found
Reproductive Success	Emergence & hatching success	Standard survey protocol	Numbers of the following: unhatched eggs, depredated nests and eggs, live pipped eggs, dead pipped eggs, live hatchlings in nest, dead hatchlings in nest, hatchlings emerged, disoriented hatchlings, depredated hatchlings

MARINE TURTLE HOLDING FACILITY QUARTERLY REPORT

ORGANIZATION AND PERMIT NUMBER _____

MONTHS AND YEAR OF REPORT _____

SECTION 1. Marine turtles maintained during the quarter. Instructions: List all marine turtles held during the quarter using the codes below. Be sure to complete/update associated information for each animal each quarter.

SID #: This is a State Identification number assigned to each turtle held at your facility (excluding hatchlings listed on the hatchling report form). Each time you receive a new turtle contact the FWC office in Tequesta at (561) 575-5407 to obtain an SID # for that animal.

SPECIES CODES: CC = *Caretta caretta*, CM = *Chelonia mydas*, LK = *Lepidochelys kempi*, EI = *Eretmochelys imbricata*, LO = *Lepidochelys olivacea*, DC = *Dermochelys coriacea*

DATE ACQUIRED: Report the date that your facility received the turtle. Under one of the last two columns indicate where the turtle came from (e.g., stranding, received from another facility, dropped off anonymously, etc.)

SIZE CODES: Hatchling = < 5cm carapace length (CL) for CC, CM, LK, EI and LO

Post-hatchling = > 5cm CL and < 10cm CL for CC, CM, LK, EI and LO

Juvenile = > 10cm CL and (1) < 45cm CL for LK and LO, (2) < 50cm CL for EI, (3) < 60cm CL for CC and CM

Subadult = > 45cm CL and < 60cm CL for LK and LO, (2) > 50cm and < 70cm CL for EI, (3) > 60cm and < 90cm CL for CC and CM

Adult = > 60cm CL for LK and LO, > 70cm CL for EI, and > 90 cm CL for CC and CM

STATUS CODES: UR = undergoing rehabilitation

ED = educational display animal (only loggerheads can be held solely for educational display. If you list any other species (i.e., a green turtle) as an educational display you must list another code as the primary purpose for holding.)

UO = unknown origin or other origin (i.e., turtles that are not from the Western Atlantic Ocean or the Gulf of Mexico)

PD = permanently disabled (indicate disability on initial report)

PREACT = pre-act animal (turtles that have been held in captivity since before 1978)

RESEARCH = turtles being held for research (requires pre-approval)

RFR = turtles that are ready for release

TSR = an otherwise healthy turtle being held until it reaches the appropriate size class for release in Florida waters

DATE RELEASED/TRANSFERRED/DIED: In this column indicate if the turtle was released, transferred to another facility, or died. If the turtle was released or if it died include the date. If the turtle was transferred to another facility include the date it was transferred and the facility it was transferred to.

SID #	SPECIES	DATE ACQUIRED	SIZE	STATUS (INCLUDE TAG# IF APPLICABLE)	DATE RELEASED/TRANSFERRED/DIED

MARINE TURTLE CAPTIVE FACILITY QUARTERLY REPORT
FOR HATCHLINGS (no SID # required)

ORGANIZATION AND PERMIT NUMBER		MONTHS AND YEAR OF REPORT				
SPECIES	BALANCE FROM PREVIOUS QUARTER	# OF HATCHLINGS ACQUIRED DURING QUARTER	# OF HATCHLINGS THAT DIED DURING QUARTER	# OF HATCHLINGS RELEASED DURING QUARTER	END OF QUARTER BALANCE	# OF RELEASES FROM BEACH VS. OFFSHORE*
LOGGERHEAD						
GREEN						
LEATHERBACK						
OTHER						
UNKNOWN						

* Hatchlings recovered from excavated nests or found disoriented should be kept on moist sand until they can be released off the beach. Hatchlings that have washed in should be kept in water until they can be released offshore. ALL HATCHLINGS SHOULD BE RELEASED AS SOON AS POSSIBLE. If you need assistance with offshore release, please contact the Tequesta office at (561) 575-5407.

COMMENTS: _____

Reporting an Obstructed Nesting Attempt (ONA)

Permit Holder Initials Year Month Day Dis. # by Day County Code

FWC MARINE TURTLE DISORIENTATION REPORT FORM

If you have any questions please contact FWC at the Tequesta Field Laboratory (561) 575-5407

Fax reports to: (561) 743-6228 or Email reports to: SeaTurtleLighting@MyFWC.com

Send reports to: Disorientation Reports, FWC, 19100 SE Federal Highway, Tequesta, FL 33455

Turtle Permit #: _____ Date of Incident: _____

Observer's Name: _____

Telephone (include area code): _____ E-mail address: _____

Location of Disoriented Nest: (address, beach name and/or nearest landmark): _____

GPS Coordinates of nest location (in the WGS projection in decimal degrees i.e., Lat 26.845412 Long -80.458796):

Latitude _____ Longitude _____

City: _____ County: _____

Local nest ID#: _____ Zone nest was located in: _____

Addresses/landmarks hatchlings disoriented towards: _____

What type(s) of light(s) were identified as a probable/possible lighting source? (please circle)

- parking lot
- dune crossover
- restaurant/bar
- pier
- sign
- street light
- single family home (interior)
- single family home (exterior)
- too many lights present to determine
- other: _____
- condominium (interior)
- condominium (exterior)
- sky glow/urban glow
- no possible lights observed

**If you circled "Too many lights present to determine" please circle what lights were present in area*

Describe lighting source(s); include number, fixture type & location of lights observed (use back if necessary): _____

GPS Coordinates of light sources, or the properties with the light sources that caused the disorientation:

Lat¹ _____ Long¹ _____ Lat² _____ Long² _____
Lat³ _____ Long³ _____ Lat⁴ _____ Long⁴ _____

Please report GPS Coordinates in the WGS projection in decimal degrees (i.e., Lat 26.845412 Long -80.458796)

Incident was documented during (circle one): MORNING SURVEY NIGHT SURVEY

Was this a caged nest? YES** _____ NO _____ **If yes: (circle one) RESTRAINING SELF-RELEASING

Was a temporary light barrier used (i.e. Silt screen)? YES _____ NO _____

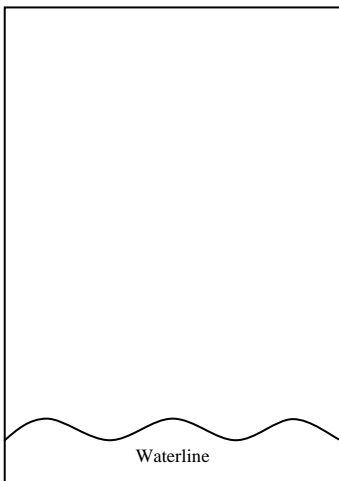

Was this a relocated nest? YES _____ NO _____

Was the incident photographed? YES _____ NO _____

Was the nest located? YES _____ NO _____

Was the nest excavated? YES _____ NO _____

If yes, provide date of excavation? _____

ADULT EVENT: Nest False Crawl HATCHLING EVENT

	LOGGERHEAD	GREEN	LEATHERBACK	UNIDENTIFIED
No. OF TURTLES DISORIENTED				
No. OF TURTLES FOUND DEAD				
No. OF TURTLES FOUND ALIVE				
No. OF DISORIENTED TURTLES REACHING WATER				

Additional comments (please elaborate and use back if necessary): _____

Was local authority provided a copy of this report? YES _____ NO _____

City: _____ County: _____ Other: _____

Signature of Observer _____

Date _____

**FISH AND WILDLIFE RESEARCH INSTITUTE
 FLORIDA FISH AND WILDLIFE CONSERVATION COMMISSION
 MARINE TURTLE NECROPSY REPORT**

STRANDING REFERENCE:

DATE NECROPSIED:

DATE OF DEATH (IF KNOWN):

SPECIES:

SEX: MALE FEMALE UNDETERMINED

NECROPSIED BY:

MEASUREMENTS: CLSL:
 CWSL:
 CLOC:
 CWOC:
 PLASTRON LENGTH:
 HEAD WIDTH:
 GCLSL:
 NNCLSL:

DISPOSITION OF CARCASS:

SPECIMEN COLLECTION CHECKLIST

SPECIMEN	FIXED	FROZEN BAGGED	FROZEN FOIL	OTHER (SPECIFY)

**PLEASE TYPE OR PRINT CLEARLY. ELECTRONIC VERSION AVAILABLE FROM FWC.
 GROSS FINDINGS**

STRANDING REFERENCE NO.

EXTERNAL:

SKELETAL MUSCLE AND FAT:

GASTROINTESTINAL TRACT (INCLUDING LIVER, SPLEEN, PANCREAS, MESENTERY):

LUNGS AND HEART (INCLUDING TRACHEA, BRONCHI, GREAT VESSELS):

UROGENITAL SYSTEM (INCLUDING KIDNEYS, BLADDER, GONADS):

OTHER COMMENTS:

FIBROPAPILLOMA DOCUMENTATION FORM

Please complete for all green turtle strandings, and for any other species that exhibits fibropapillomas. Please submit with the STSSN report form.

Observer: _____ Stranding Date: _____

Stranding Number by Day: _____ Species: _____

1. Please circle sites where tumors are present:

Left Eye	Right Eye	Inside Mouth	Neck
Base Front Flippers	Base Rear Flippers	Along Front Flippers	Along Rear Flippers
Around Tail	On Carapace	On Plastron	Other _____

2. How many fibropapillomas are less than 1 cm in diameter? (circle one)

0 1 - 5 greater than 5

3. How many fibropapillomas are between 1 cm and 4 cm in diameter? (circle one)

0 1 - 5 greater than 5

4. How many fibropapillomas are between 4 cm and 10 cm in diameter? (circle one)

0 1 - 3 greater than 3

5. How many fibropapillomas are greater than 10 cm? (circle one)

0 1 - 3 greater than 3

6. Do you believe that vision was blocked by fibropapillomas? (circle one)

No Yes, in Left Eye Yes, in Right Eye Yes, in Both Eyes

7. Please describe the size and exact location of any fibropapillomas inside the mouth.

Please be sure to take at least one ventral, one dorsal, and one "head-on" photograph of the turtle. If there is a fibropapilloma inside the mouth, please take a photograph of it. *If the turtle is not a green turtle, or if it has fibropapillomas inside the mouth, please salvage the turtle and page the FWC turtle staff at 1-800-241-4653, pager number 274-4867.*

SEA TURTLE STRANDING AND SALVAGE NETWORK – STRANDING REPORT

OBSERVER'S NAME / ADDRESS / PHONE:
 First _____ M.I. ____ Last _____
 Affiliation _____
 Address _____

 Area code/Phone number _____

STRANDING DATE:
 Year 20__ __ Month __ __ Day __ __
 Turtle number by day __ __

*State coordinator must be notified within 24 hrs:
 this was done by* phone (561)575-5407
 email fax (561)743-6228

SPECIES: (check one)
 CC = Loggerhead
 CM = Green
 DC = Leatherback
 EI = Hawksbill
 LK = Kemp's ridley
 LO = Olive ridley
 UN = Unidentified
Check Unidentified if not positive. Do Not Guess.

 Photos taken? Yes No
 Species verified by state coordinator? Yes No

STRANDING LOCATION: Offshore (Atlantic or Gulf beach) Inshore (bay, river, sound, inlet, etc)
 State _____ County _____
 Descriptive location (be specific) _____

 Latitude _____ Longitude _____

CONDITION: (check one)
 0 = Alive
 1 = Fresh dead
 2 = Moderately decomposed
 3 = Severely decomposed
 4 = Dried carcass
 5 = Skeleton, bones only

FINAL DISPOSITION: (check one)
 1 = Left on beach where found; painted? Yes* No(5)
 2 = Buried: on beach / off beach;
 carcass painted before buried? Yes* No
 3 = Salvaged: all / part(s), what/why? _____

 4 = Pulled up on beach/dune; painted? Yes* No
 6 = Alive, released
 7 = Alive, taken to rehab. facility, where? _____

 8 = Left floating, not recovered; painted? Yes* No
 9 = Disposition unknown, explain _____

**If painted, what color? _____*

SEX: (check one)
 Immature, undetermined
 Female Male
 How was sex determined?
 Necropsy
 Tail length (adult only)
 Length of tail beyond carapace _____ cm / in

TAGS: Contact state coordinator before disposing of any tagged animal!!
 Flipper tags present? Yes No
Check all 4 flippers. If found, record tag number(s) / tag location / return address

 PIT tag scan? Yes No
 If found, record number / tag location

 Coded wire tag scan? Yes No
 If positive response, record location (flipper)

 Checked for living tag? Yes No
 If found, record location (scute number & side)

CARAPACE MEASUREMENTS: (see drawing)

Using calipers	Circle unit
Straight length (NOTCH-TIP)	_____ cm / in
Minimum length (NOTCH-NOTCH)	_____ cm / in
Straight width (Widest Point)	_____ cm / in
Using non-metal measuring tape	Circle unit
Curved length (NOTCH-TIP)	_____ cm / in
Minimum length (NOTCH-NOTCH)	_____ cm / in
Curved width (Widest Point)	_____ cm / in
Weight <input type="checkbox"/> actual / <input type="checkbox"/> est.	Circle unit _____ kg / lb

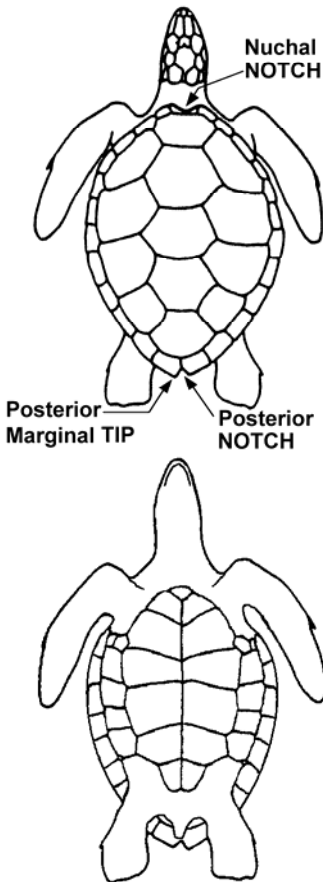

Mark wounds / abnormalities on diagrams at left and describe below (note tar or oil, gear or debris entanglement, propeller damage, epibiota, papillomas, emaciation, etc.). **Please note if no wounds / abnormalities are found.**

PICTURE GUIDE TO SPECIES OCCURRING IN THE AREA

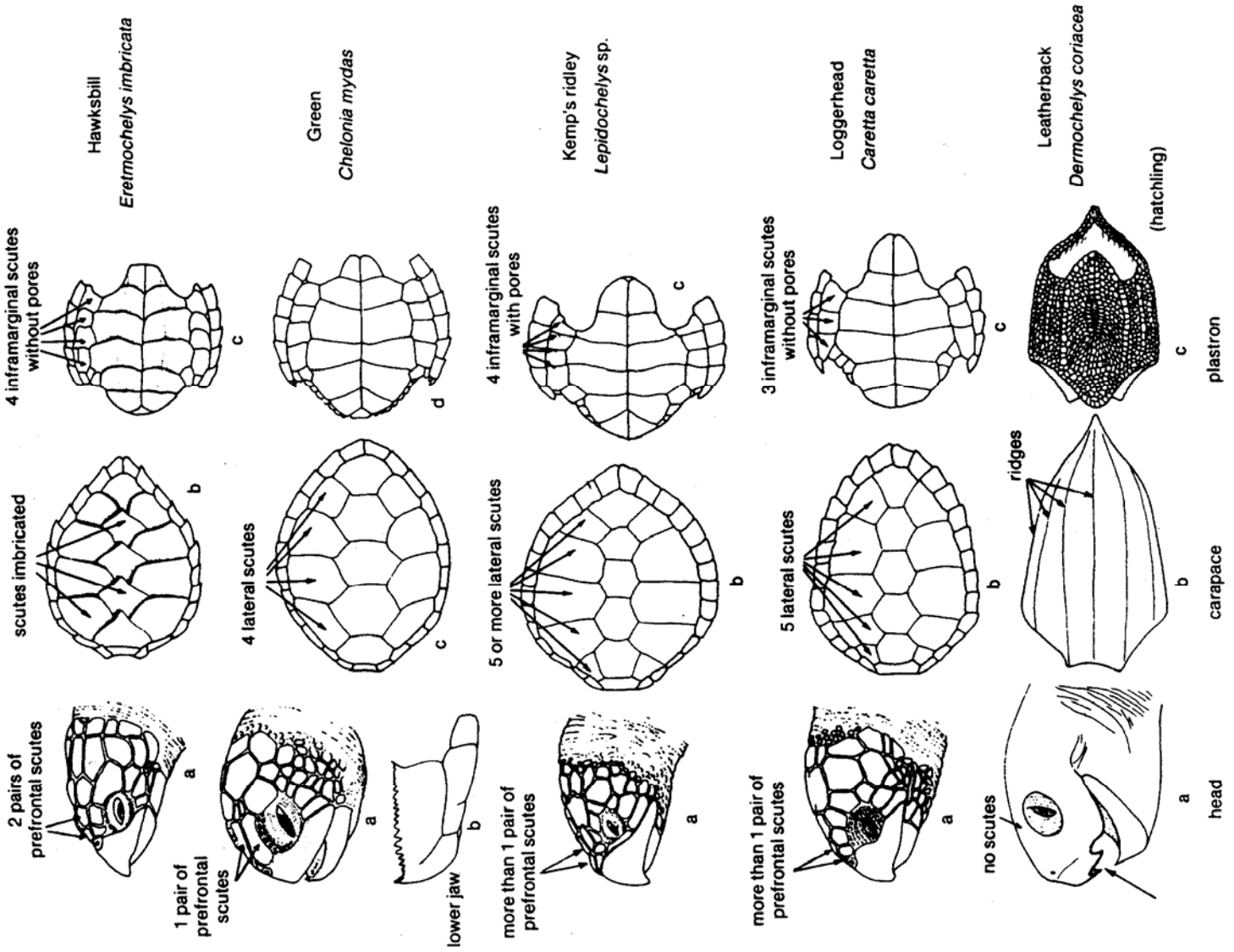

PLEASE FAX TO (561)743-6228, THEN PLEASE USE AN ENVELOPE AND MAIL ORIGINAL FORM TO:

FLORIDA STSSN COORDINATOR
 FLORIDA FISH & WILDLIFE CONSERVATION COMMISSION
 FISH & WILDLIFE RESEARCH INSTITUTE
 19100 SE FEDERAL HIGHWAY
 TEQUESTA, FL 33469

**COOPERATIVE MARINE TURTLE TAGGING PROGRAM (CMTTP)
TAGGING DATA FORM**

SPECIES: _____	DATE CAPTURED:	DAY__	MO____	YR____	DATE RELEASED:	DAY____	MO____	YR____
TAG NUMBERS (LIST ALL NUMBERS AND LETTER PREFIXES; CIRCLE TAG NUMBERS ALREADY ON THE TURTLE [= "OLD TAGS"]):								
LEFT FRONT: _____	RIGHT FRONT: _____			LEFT REAR: _____	RIGHT REAR: _____			
PIT TAG#: _____				LOCATION OF PIT TAG: _____				
WAS TURTLE CARRYING TAGS WHEN ENCOUNTERED?:			YES	NO	IF YES, THEN CIRCLE CORRECT STATEMENT:			
1. RECAPTURE OF SAME PROJECT TURTLE (EITHER WITHIN SEASON OR BETWEEN SEASONS)								
2. RECAPTURE OF DIFFERENT PROJECT TURTLE (NOT A TAG YOUR GROUP APPLIED)								
TAG RETURN ADDRESS:								
ORGANIZATION TAGGING AND/OR RELEASING TURTLE (INCLUDE AREA CODE/PHONE NUMBER; AND EMAIL):								
PROJECT TYPE (CIRCLE ONE):								
[NESTING BEACH]	[TANGLE NET]	[POUND NET]	[HAND CATCH]	[STRANDING]	[OTHER, DESCRIBE]			
IF NESTING BEACH: DID TURTLE NEST?		YES	NO	UNDETERMINED				
FACILITY WHERE TURTLE WAS BEING HELD:								
DESCRIBE CAPTURE LOCATION. BE SPECIFIC, INCLUDE COUNTY AND LAT/LONG IF AVAILABLE								
DESCRIBE RELEASE LOCATION. BE SPECIFIC, INCLUDE COUNTY AND LAT/LONG IF AVAILABLE.								
TURTLE MEASUREMENTS:								
STRAIGHT CARAPACE LENGTH (SCLMINIMUM):		_____ CM			_____ INCHES			
STRAIGHT CARAPACE LENGTH (SCLNOTCH-TIP):		_____ CM			_____ INCHES			
STRAIGHT CARAPACE WIDTH (SCW):		_____ CM			_____ INCHES			
CURVED CARAPACE LENGTH (CCLMINIMUM):		_____ CM			_____ INCHES			
CURVED CARAPACE LENGTH (CCLNOTCH-TIP):		_____ CM			_____ INCHES			
CURVED CARAPACE WIDTH (CCW):		_____ CM			_____ INCHES			
WEIGHT:		_____ KG			_____ LBS			
TURTLE WAS INSPECTED AND/OR SCANNED FOR:								
TAG SCARS:	YES	NO	WHERE LOCATED?					
PIT TAGS:	YES	NO	WHAT FREQUENCY?					
MAGNETIC WIRES:	YES	NO	WHERE LOCATED?					
LIVING TAGS:	YES	NO	WHERE LOCATED?					
ADDITIONAL REMARKS OR DATA ON BACK OF FORM:			YES	NO				
MAIL COMPLETED FORM TO: ARCHIE CARR CENTER FOR SEA TURTLE RESEARCH, DEPARTMENT OF ZOOLOGY, PO Box 118525 UNIVERSITY OF FLORIDA, GAINESVILLE, FL 32611 USA								

FWC MARINE TURTLE TRANSFER FORM

Instructions: This form must be filled out completely whenever a marine turtle is transferred from one facility to another. A copy of each completed form should be submitted (by both the transferring and the receiving facility) with the quarterly report for the quarter in which the animal was transferred.

Turtle's State Identification Number (**SID #**): _____

Turtle's Stranding Identification Number: _____
(If applicable)

Date of Transfer: _____

Transferring turtle **FROM** (name of facility) _____

Transferring turtle **TO** (name of facility) _____

Purpose of transfer: _____

Transfer is expected to be (circle one): Temporary Permanent

Other Comments: _____



APPENDIX B – GLOSSARY OF TERMS



APPENDIX B - GLOSSARY OF TERMS

Archie Carr National Wildlife Refuge (ACNWR): The nation's only refuge specifically designated to protect marine turtles. The ACNWR, established in 1990 in honor of Dr. Archie F. Carr, Jr. for his contribution and dedication to the conservation of marine turtles, stretches approximately 20 miles along Florida's central Atlantic coast (in Brevard and Indian River Counties). This area attracts more marine turtle nesting than any other place in the U.S.

Armoring: The use of structures such as sea walls, rock revetments, sandbags/sand tubes, and other rigid structures to protect coastal property from erosion.

Artificial Lighting: Light sources that are produced by humans.

Backstop: An approximately 45° incline made in the sand as sand is pushed back with the rear flippers during the excavation of the primary body pit. Such a steeply inclined backstop is not present in the secondary body pit.

Beach Nourishment: Beach nourishment is a process involving the mechanical dumping or pumping of sand onto an eroded beach. Although beach nourishment is a preferred alternative to armoring, the suitability of the renourished beach for marine turtle nesting is dependent on the quality of sand being placed on the beach and the method used to deposit it.

CITES: The Convention on International Trade in Endangered Species of Wild Fauna and Flora (CITES), is a multinational agreement that regulates international trade in certain plant and animal species in order to prevent their overexploitation.

Clutch: The number of eggs laid in a single nest, excluding 'yolkless' eggs (yolkless eggs should be counted and reported separately). Extra large and multi-yolked (double or chain-form) eggs can actually contain viable embryos and should be counted as part of the clutch.

CMTTP: Cooperative Marine Turtle Tagging Program, a centralized tagging program developed to distribute tags, manage tagging data, and facilitate exchange of tag information managed by the Archie Carr Center for Sea Turtle Research (ACCSTR) at the University of Florida.

Crawl: Tracks and other signs left on a beach by a marine turtle.

Disorientation: Loss of orientation. Being unable to maintain constant directional movement. For hatchling and adult marine turtles on the beach, travel in random directions due to orientation to artificial lighting along or on the beach.

Egg (normal): Spherical, white and comprised of a pliable shell, a capsule of albumen and a yolk..

Egg (abnormal): Extra large (greater than ¼ larger in diameter than normal eggs of that species, multi-yolked (double or chain-form) or very small (less than ½ the diameter of normal eggs of that species) when compared to the other eggs in the clutch. Extra large diameter eggs typically contain

two yolks. The very small eggs are commonly termed ‘yolkless’ eggs that contain mostly albumen and a few granules, or more, of yolk encapsulated by a shell but no embryonic disc.

Egg Chamber: The vase-shaped cavity excavated by the rear flippers of a nesting turtle into which the turtle deposits a clutch of eggs.

Emergence: A female turtle exiting the water onto the beach, or hatchlings exiting the nest.

Escarpment: The perimeter of the secondary body pit where the front flippers have cut away a small cliff into the surrounding sand.

False Crawl: An aborted nesting attempt (emergence onto a beach) by a marine turtle. A more correct term is “non-nesting emergence”.

Fibropapillomatosis (FP): Tumor-like growths commonly found on green turtles but observed on all species of marine turtle. FP can result in reduced vision, disorientation, blindness, physical obstruction to normal swimming and feeding, an apparent increased susceptibility to parasitism by marine leeches, and an increased susceptibility to entanglement in monofilament fishing line.

Hatch Success: The proportion of eggs in a nest that produce live hatchlings.

Misorientation: Orientation in the wrong direction. For hatchling marine turtles on the beach, travel in any direction other than the general vicinity of the ocean.

Nesting Crawl: A crawl resulting from a nesting attempt in which eggs were deposited.

Nest Success: The portion of nesting attempts by a marine turtle (emergences onto the beach) that result in eggs being deposited.

Non-Manipulation or “hands off” Management Strategy: This is a proactive type of management strategy used to protect a resource from potential threats by eliminating or minimizing the threat. For example, on beaches where artificial lighting is a problem, instead of moving the nests to a darker beach (and potentially harming eggs during the relocation process or placing them in a less suitable site), attempts should be made to have offending lights shielded, redirected or turned off.

Post-Emergent Nest: A nest in which the majority of hatchlings have emerged through the surface of the sand.

Primary Body Pit: The excavation made by a turtle on the beach just prior to digging the egg chamber.

Pipped egg: An egg that has been pierced by the turtle embryo initiating the hatching process. Eggs are considered pipped from the time that the first tear is made in the shell [by the embryo] until it has completely escaped its eggshell (when it becomes a hatchling).

Secondary Body Pit: An excavation made by a nesting turtle primarily using the front flippers following the deposition of eggs. The spoil from the secondary body pit covers the primary body pit and the egg chamber with sand.

Take: An act that potentially harasses, injures or kills a protected species.

TED (Turtle Excluder Device): TEDs are used on commercial shrimping vessels to allow marine turtles the ability to escape the trawl net. The TED is a grid of metal bars with an opening either at the top or the bottom. The grid fits into the narrow part of the shrimp trawl. When a large animal like a turtle hits the grid bars they will flow through the opening. Smaller animals like shrimp will pass through the bars and be caught in the net. Today, all U.S. shrimpers are required to put TEDs in their trawl nets.

Yolkless eggs: [Usually smaller than normal] eggs that do not contain yolk. Yolkless eggs are commonly deposited with yolked eggs by leatherback, hawksbill and occasionally loggerhead turtles.



APPENDIX C – RESOURCES

-
- List of Local Government Lighting Ordinances
 - Nest Signs
 - Educational Web Site Links
 - Bumper Stickers and other Educational Brochures
 - Selected References
 - License Plate Information
 - Decal Information

SEA TURTLE PROTECTION ORDINANCES ADOPTED BY COUNTIES AND MUNICIPALITIES (as of 01/02/08)			
COUNTY/ MUNICIPALITY	DATE ADOPTED/ UPDATED	ORDINANCE # / LOCATION IN CODE	CODE ENFORCEMENT/ CONTACT
BAY	2004	Appendix C, Chapter 19, Sec. 1917(Ord 02-07)	Scott Hair (850) 784-4038
Mexico Beach	2001	Ord 339	John Grantland (850) 648-5700
BREVARD	1985/1990/1993	Chapter 46, Article III	Paula Bernston (321) 633-2016
Cape Canaveral	1990	Chapter 14, Article III	Duree Alexander (321) 868-1222
Cocoa Beach	1986	LDC, Chapter IV, Article XI	Robin Reiland (321) 868-3217
Indialantic	1986	Chapter 5, Division 3	Ron Cassidy (321) 984-5224
Indian Harbor Beach	1987	Ord 87-8	Jackie Burns (321) 773-3181
Melbourne Beach	1986	Ord 86-5	William Whitelock (321) 724-5860
Satellite Beach	1990/1993	Chapter 66, Article II, Division 3 / Chapter 30, Article V, Division 8, Sec 30-546	Sean Donovan (321)773-4409
BROWARD	1989	Chapter 39, Article IX, Sec 39-107	Susan Pierce (954) 468-3551
Deerfield Beach	2000	Chapter 34, Article V, Sec 34-96	Jenny Walsh (954) 480-4241
Ft. Lauderdale	2003	Chapter 6, Article III	Mario Sotolongo (954) 828-6326
Hillsboro Beach	2006 (Expires without voters' referendum on April 1, 2009)	Chapter 12, Division 5, Art. XIV	Police Department (954)427-6600
Lauderdale By The Sea	2002		Richard Mesiano (954) 776-5119
Pompano Beach	1999	Ord 99-18, 2000-64	Richard Kirby (954) 786-4361
CHARLOTTE	1989/1998	Chapter 3-5, Article XII	Missy Christie (941) 743-1919

APPENDIX C - RESOURCES

COLLIER	1988/1992	LDC, Chapter 3, 3.04.02, Part B	Maura Kraus (239) 732-2505
Marco Island	1998	Ord 99-7: Chapter 6, Article V; Chapter 54, Article V	Nancy Richie (239) 389-5000
Naples	1982/1995	Chapter 52, Article IV, Sec 52-61	Maura Kraus (239) 732-2505
MIAMI-DADE	No ordinance		
Golden Beach	1997	Chapter 58, Article III	Robert Ruggiero (305) 932-0744
Miami Beach	2006	Chapter 46, Article V	Code Compliance Division (305)673-7555
DUVAL	No ordinance		
Jacksonville Beach	2000	Chapter 6, Article I, Sec 6-8	Debbie White (904)247-6232
Neptune Beach	1999	Chapter 8, Article VII, Division III	John Webber (904) 270-2400 x4
ESCAMBIA	No ordinance		
FLAGLER	2001	Appendix C, Article VI, 6.05.55	Walter Fufidio (386) 437-7487
Flagler Beach	1987/2000	Appendix A, Article IV, Sec 4.04.00	Elaine Cowart (386) 517-2005
FRANKLIN	1998	Chapter 5, Article IV (Ord 98-11)	Alan Pierce (850) 653-9783 x161
St. George Island			Lauren Wright (850) 670-4783 ext. 114
GULF	2001	Ord 2001-09	Michael Aiken (850)229-8944
HILLSBOROUGH	No ordinance		
INDIAN RIVER	1987/1994	Title IX, Chapter 932, Section 932.09	Roland DeBlois (772) 567-8000 ext. 258

Indian River Shores	1986/2000	Ord 460	Robert Bradshaw (772) 231-1771
Orchid	1993	Chapter 58, Sec 58-8 / Chapter 78, Sec 78-12 part (e)	Deb Branwell (772) 569-7686
Vero Beach	1990 / 1993	Chapter 46, Article IV, Division 2	Susan Clifton and David Checchi (772) 978-4561
LEE	1989/1998	LDC, Chapter 14, Article II, Division 2	Carol Lis (239) 479-8353, SunCom: 726-8353
Bonita Springs	2001	Ord 01-06	Christopher Campbell (239) 949-6257
Ft. Myers Beach	1989/1998	Ord 98-3	Steve Lane (239) 765-0202
Sanibel	1997/2000	Chapter 126, Article XIV, Division 4	James Evans (239) 472-3700 ext. 377
MANATEE	No Ordinance		
Anna Maria Island	2003	Chapter 14, Article II	Gerry Rathvon (941) 708-6130
Bradenton Beach	1998/2005	Chapter 10, Article II	Gail Garneau (941) 778-1005
Holmes Beach	1987	Part II, Chapter 66, Article II, Division 2	Nancy Hall (941)708-5800 ext. 2
MARTIN	1988	LDC, Article 4, Division 4, Sec. 4.111	David Knight (561) 220-7018
Town of Jupiter Island	1992	Ord 208	Joe Connolly (772) 546-0100
MONROE	1994/1998	Chapter 13, Article IV	Ronda Norman (305) 289-2810 or Janis Vaseras (305) 289-2537
Key West	1995	Chapter 10, Article VI	Cassandra Butler (305) 292-8128
Marathon	1994/1998	Chapter 14, Article III (Ord 31198)	Michael Storm or Cynthia McPherson (305)289-4116
Village of Islamorada	1998/2002	Chapter 30, Article VII, Division 3	George Martel (305) 664-2345
NASSAU	1988	Chapter 7, Article XII	Officer Clemens Sheriff Department (904) 548-4000

APPENDIX C - RESOURCES

Fernandina Beach	1987/1995	Chapter 126, Article V, Sec 126-422	Fred Lindies (904) 277-7325
OKALOOSA	No ordinance		
Destin	2004	LDC, Article 7, 7.17.00 through 7.17.02	David Bazylak (850)837-4242 x3172
PALM BEACH	1987/1996/1999	LDC, Article 14, Chapter A	Jacey Biery (561) 233-2461
Boca Raton	1986/1996/2002	Chapter 23, Article IV, Division 7	Dawn Sinka (561) 393-7786
Briny Breezes**	1988	Ord 2-87	Nancy Boczon (561) 276-7405
Delray Beach	1987/2001	Title 9, Chapter 91, Sea Turtles	Richard Bauer (561) 243-7219
Gulf Stream**	1987	Division 2	Rita Taylor (561) 276-5116
Highland Beach	1987/1999	Chapter 4, Sec 4-8	Bob Dawson (561) 278-4540
Juno Beach	1998	5.125	Lynn Hamil (561) 627-0818
Ocean Ridge	1987/1993	Chapter 66, Article I, Sec 66-2	Ken Schenck (561) 732-2635
Town of Palm Beach	1987/1995	Chapter 74, Article II, Division 4	Rob Walton (561) 227-6423
Town of South Palm Beach	1988/1999/2004	Chapter 26, Article X, Division 3	Town of South Palm Beach Police Department (561)586-2122
PINELLAS	No Ordinance		
Dunedin	1991	Chapter 134, Article IX, Division 4	Debra King (727) 298-3194
Indian Rocks	1991/1999	Chapter 86, Article III, Division 2	John Ouimette (727) 517-0404
Indian Shores	1994	Chapter 14, Article III	Police Department (727) 595-5414
Madeira Beach	1990/1992/2000	Chapter 110, Article VI, Division 5	Don Lewis (727) 391-9951 x223
North Redington Beach	1990/2000	Chapter 18, Article VIII	Bruce Mercer (727) 502-7019

Redington Beach	1987/2001	Chapter 4, Sec 4-9	Mark Davis (727) 709-2097
Treasure Island	1999	Chapter 72, Article V	Carol Kitts and Del Powell (727) 547-4575 ext. 239
St. Pete Beach	2007	LDC, Division 44	Rick Smith or Lisa Giddens (727)363-9211 codes@stpetebeach.org
ST. JOHNS	1996/1999	Ord 99-33	Tara Dodson or Scott Eastman (904)209-3740
St. Augustine Beach	1995/1996	Ord 99-33; Chapter 5, Article I, Sec 5-15	Tara Dodson or Scott Eastman (904)209-3740
ST. LUCIE	1986/1991/1997	Chapter VI, Sec 6.04.02	Amy Mott (772) 462-2531
Ft. Pierce	1990/1993	Chapter 4, Article IV	Peggy Arraiz (772) 460-2200 ext.294 or Melody Sanderson ext. 280
SANTA ROSA	2005	Appendix C, Article 12, 12.14.00	TBA
SARASOTA	1997/1999/2000/2004	Chapter 54, Article XXIII	Kenya Leonard (941) 378-6142
City of Sarasota	1999	Zoning Code, Article VII, Division 14, Sec VII-1402	Kenya Leonard (941) 861-6240
Longboat Key	1987/1992/1993	Ord 87-16	Tony Sapuppo (941) 747-0677
Venice	1988/1995	Ord 95-07	John Patek (941) 486-2626 ext. 22007
VOLUSIA	1986/1989/1990/1999	Chapter 50, Article III, Division 6: Sea Turtles / Appendix A, Article XII	Steve Kintner (386) 736-5927 ext. 5851 / SunCom: 377-5851 or Michelle Leigh (386) 736-5927 ext. 2330 / SunCom: 377-5927
New Smyrna Beach	1999	(Ord 52-99) follows county code	Steve Kintner (386) 736-5927 ext. 5851 / SunCom: 377-5851 Michelle Leigh (386) 736-5927 ext. 2330 / SunCom: 377-5927
WALTON	No ordinance		

LDC = Land Development Code
 ** Indicates that compliance is voluntary

**DO NOT DISTURB
SEA TURTLE
NEST**



**VIOLATORS SUBJECT
TO FINES AND
IMPRISONMENT**

FLORIDA LAW CHAPTER 370	U.S. ENDANGERED SPECIES ACT OF 1973
No person may take, possess, disturb, mutilate, destroy, cause to be destroyed, sell, offer for sale, transfer, molest, or harass any marine turtle or its nest or eggs at any time.	No person may take, harass, harm, pursue, hunt, shoot, wound, kill, trap, or capture any marine turtle, turtle nest, and/or eggs, or attempt to engage in any such conduct.
Upon conviction, a person may be imprisoned for a period of up to 60 days or fined up to \$500, or both, plus an additional penalty of \$100 for each sea turtle egg destroyed or taken.	Any person who knowingly violates any provision of this act may be assessed a civil penalty up to \$25,000 or a criminal penalty up to \$100,000 and up to one year imprisonment.

**SHOULD YOU WITNESS A VIOLATION, OBSERVE AN INJURED
OR STRANDED TURTLE, OR MISORIENTED HATCHLINGS,
PLEASE CONTACT FWC AT**

1-888-404-FWCC OR *FWC (MOBILE PHONE)
FLORIDA FISH AND WILDLIFE CONSERVATION COMMISSION
MARINE TURTLE PROTECTION PROGRAM

To order nesting signs, contact Imperiled Species Management (ISM) staff at (850) 922-4330 or (561) 575-5407. Individual ordering nest signs must be listed on a marine turtle permit.

SEA TURTLE RELATED WEB SITES

Caribbean Conservation Corporation/Sea Turtle Survival League (information on Sea Turtle Migration Tracking Education Program, site links, and other resources)

<http://www.ccturtle.org>

The Ocean Conservancy [*formerly Center for Marine Conservation*] (educational publications and materials on marine environments)

<http://www.oceanconservancy.org> (use their search to find turtle information)

CITES (Convention on International Trade in Endangered Species of Wild Fauna and Flora; CITES-listed species database and information in international commercial trade)

<http://international.fws.gov/cites/cites.html>

Environmental Protection Agency, Gulf Information Network (sea stats on turtles in the Gulf of Mexico, also, many other environmental resources for teachers)

<http://www.epa.gov/gmpo/>

Euroturtle (Mediterranean sea turtles and general sea turtle information)

<http://www.euroturtle.org/>

Florida Fish and Wildlife Conservation Commission, Division of Habitat and Species Conservation, Imperiled Species Management Section (information on conservation and management of sea turtles in Florida, links to sea turtle conservation groups)

<http://www.myfwc.com/seaturtle/>

Florida Fish and Wildlife Conservation Commission, Fish and Wildlife Research Institute (information on sea turtle research, nesting, and stranding in Florida)

<http://research.myfwc.com/> (look under Saltwater section header)

Marine Turtle Newsletter (primary research/news regarding biology and conservation of sea turtles)

<http://www.seaturtle.org/mtn>

Mote Marine Laboratory (information on education programming)

<http://www.mote.org/> (look on main page for turtle rehabilitation information, also look under "programs" for more turtle information)

Seaturtle.org (provide online resources including sea turtle directory, news, image library, free GIS maptool, satellite tracking center and links)

<http://www.seaturtle.org/>

The Archie Carr Center for Sea Turtle Research (CTURTLE information (a sea turtle list server discussion group) and the Sea Turtle On-Line Bibliography (great for research papers))

<http://accstr.ufl.edu/biblio.html>

United States Fish and Wildlife Service (information of endangered species and habitats)
<http://www.fws.gov> (look under "endangered species", also search "sea turtles" for more information)

United States National Marine Fisheries Services (information on sea turtles, and NMFS role in protection)
http://www.nmfs.noaa.gov/prot_res/prot_res.html

Wildlife and Zoological Medicine (University of Florida College of Veterinary Medicine; information on green turtle fibropapilloma disease)
<http://sacs.vetmed.ufl.edu/Services/ZooMed/stf.htm>

Turtle Trax (website by Canadian teacher and turtle advocate Ursula Keuper-Bennet)
www.turtles.org

LIST SERVES

Turtle Rehab eGroup (<http://groups.yahoo.com/group/turtlerehab/>) – A private group where members can discuss current issues relating to sea turtle rescue and rehabilitation in Florida.

Sea Turtle Stranding Network eGroup (<http://groups.yahoo.com/group/flstssn/>) – A private group where members can discuss current issues relating to sea turtle strandings in Florida.

Permit Holder eGroup (<http://groups.yahoo.com/group/flpermitholder/>) – A private group where members can discuss any issues pertinent to sea turtle conservation in the state of Florida.

To order “Share the Beach” brochures, contact Imperiled Species Management (ISM) staff at either (850) 922-4330 or (561) 575-5407.

To order Florida Power and Light (FPL) bumper sticker or brochures, contact FPL at (800) 552-8440.

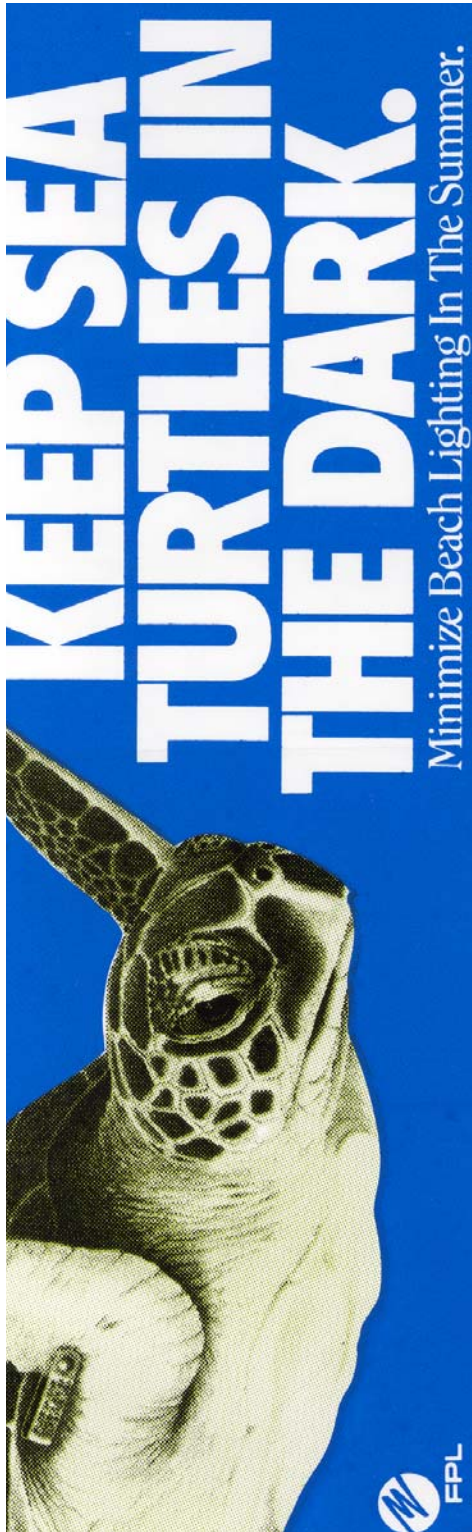

Florida sea turtles **Share the beach**



**Helpful information for
beach visitors during sea
turtle nesting season**



**Florida Fish and Wildlife
Conservation Commission**
MyFWC.com

Sea Turtles and Lights

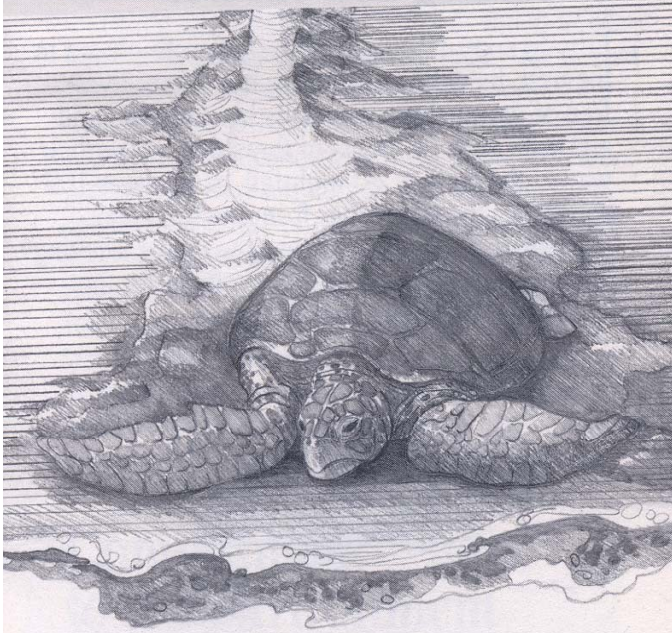

Florida's endangered sea turtles need your help

Each summer, Florida beaches host the largest gathering of nesting sea turtles in the United States. Female sea turtles emerge from the surf to deposit eggs in sand nests and later, tiny hatchlings struggle from their nests and scramble to the ocean. Nearly all of this activity takes place under cover of darkness and relies upon natural light environment too often disrupted by the addition of artificial lighting.

Florida's Sea Turtles

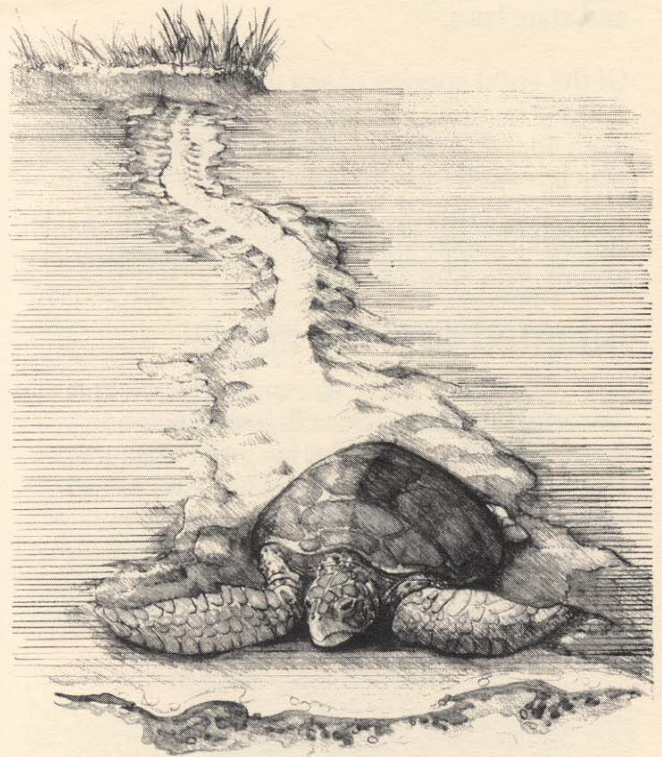



Fish & Wildlife Conservation Commission

Florida Marine Research Institute

Sea turtles are among the oldest creatures on earth and have remained essentially unchanged for 110 million years. However, they face an uncertain future. Sea turtles are threatened in many ways, such as encroachment of coastal development on their nesting beaches, encounters with pollutants and marine debris, accidental drownings in fishing gear, and international trade in turtle meat and products.

Information about these ancient nomads of the deep has until recently focused on nesting females and hatchlings because they are the easiest to find and study. The advent of new research techniques, such as satellite tracking technology, has allowed scientists to peer into other phases of their lives. Florida, a leader in sea turtle research and conservation, is home to the nation's only refuge designated specifically for sea turtles. On Florida's east coast, the Archie Carr National Wildlife Refuge, named after the pioneering researcher whose work first called attention to the plight of the sea turtles, serves as a nursery for approximately one-quarter of all loggerhead turtle nests in the Western Hemisphere.

Description

Sea turtles are air-breathing reptiles remarkably suited to life in the sea. Their hydrodynamic shape, large size, and powerful front flippers allow them to dive to great depths and swim long distances. After their first frantic crawl from the nest to the ocean, male sea turtles never return to the shore again, and females come back only long enough to lay eggs.

There are seven species of sea turtle: green turtle, hawksbill, leatherback, loggerhead, olive ridley, Kemp's ridley, and flatback. All but the olive ridley and flatback are found in Florida. Sea turtles have long and narrow wing-like flippers in place of forelimbs and have shorter webbed flippers as hind limbs; unlike their terrestrial

SEA TURTLES

Nomads of the Deep

relatives, they cannot retract their heads very far into their shells.

In most sea turtles, the top shell, or carapace, is composed of many bones covered with horny scales or "scutes." Turtles are toothless but have powerful jaws to crush, bite, and tear their food.

The smallest of the sea turtles are the ridleys, weighing in at 85 to 100 pounds as adults. Leatherbacks are the

behemoths and can grow to 2,000 pounds. Most sea turtles grow slowly and have a life-span of many decades. Although sea turtles can remain submerged for hours at a time while resting or sleeping, they typically surface several times each hour to breathe.

In summer, an ancient reproductive ritual begins when the female leaves the sea and crawls ashore to dig a nest in the sand. She uses her rear flippers to dig the nest hole and then she deposits about 100 eggs the size of ping-pong balls.

FAST FACT

Female sea turtles often appear to be weeping as they nest; the main purpose for these tears is to remove salt from the turtle's body.

When egg-laying is complete, the turtle covers the eggs, camouflages the nest site, and returns to the ocean. Nesting turtles may return several times in a nesting season to repeat the process and usually nest every two to three years.

As is true for some other reptiles, the temperature of the sea turtle nest determines the sex of the hatchlings. Warmer temperatures produce more females, whereas cooler temperatures result in more males. Consequently, conservationists prefer to leave turtle eggs in their original location whenever possible so that sex ratios are determined naturally.

To order Sea Stats please visit http://research.myfwc.com/education/view_Art..asp?id=9602.

SELECTED REFERENCES

Bjorndal, Karen A. (Editor). 1995. *Biology and Conservation of Sea Turtles*.

Eckert, K.L., K.A. Bjorndal, F.A. Abreu-Grobois, and M. Donnelly (Editors). 1999. *Research and Management Techniques for the Conservation of Sea Turtles*. IUCN/SSC Marine Turtle Specialist Group Publication No. 4.

Herbst, L.H. and E.R. Jacobson. *Recommendations for Activities Involving Brief Captivity with Non-Invasive or Minimally Invasive Procedures*.

Lorne, Jacquelyn K and Michael Salmon. 2007. *Effects of exposure to artificial lighting on orientation of hatchling sea turtles on the beach and in the ocean*. Endang Species Res. Vol. 3: 23–30.

Lutz, Peter L. and John A. Musick (Editors). 1997. *The Biology of Sea Turtles*.

Witherington, Blair E. and R. Erik Martin. 2000. *Understanding, Assessing, and Resolving Light-Pollution Problems on Sea Turtle Nesting Beaches*. 2nd edition revised. Florida Marine Research Institute Technical Report TR-2. 73 p.

Wolke, Richard E. and Anita George. *Sea Turtle Necropsy Manual*. NOAA Technical Memorandum NMFS-SEFC-24 (1981).

Wyneken J, Salmon M, Fisher L, Weege S. 2000 *Managing relocated sea turtle nests in open-beach hatcheries. Lessons in hatchery design and implementation in Hillsborough Beach, Broward County, Florida, USA*. In: Kalb H, Wibbels T (compilers) Proc 19th Annual Sea Turtle Symposium, Miami. US Dept. of Commerce, NOAA Tech Memo NMFS–SEFSC–433. Miami, p 193–194

Martin, R. Erik. Personal communication on track widths

APHIS recommendations for marine mammals¹

SEA TURTLE LICENSE PLATE

The Sea Turtle License Plate became available for purchase in February of 1998. Proceeds from the plate are deposited in the Marine Resources Conservation Trust Fund and used to support the state's sea turtle recovery program. The license plate provides \$500,000 in funding annually to the state's Marine Turtle Protection Program. The plate was also developed to provide a small grants program to help fund non-profit groups, educational facilities and local governments working to protect sea turtles in Florida. The plate is available at your local tax collector's office for an annual fee of \$23.00.

SEA TURTLE DECALS

The *Florida's Sea Turtles* decal series has been produced annually since 1992. Proceeds from the decals provide a funding source for the state's sea turtle recovery program. Sales from the decals have provided an annual average of \$60,000 for the program. Current year decals can be purchased for \$5.00 each at your local tax collector's office. Decals from all years are available through ISM in Tallahassee or Tequesta, as well as through FWRI in St. Petersburg.



APPENDIX D – QUICK REFERENCE TABLES

-
- Table D-1. Authorized Activities
 - Table D-2. Reporting Requirements
 - Table D-3. Why's and How's of Nest Protection and Marking
 - Table D-4. Conducting Nesting Surveys & Related Activities

Table D-1. Authorized Activities.

AUTHORIZED ACTIVITY	INCLUDES:	NOT AUTHORIZED TO (UNLESS OTHERWISE STATED ON PERMIT):
CONDUCT EDUCATIONAL SNORKEL/DIVE PROGRAMS	<ul style="list-style-type: none"> ▶ Allowing people to snorkel and/or dive in tanks holding marine turtles. ▶ Holding loggerheads for educational display. 	<ul style="list-style-type: none"> ▶ Allow snorkel/dive participants to approach, touch or handle marine turtles.
CONDUCT HATCHING SUCCESS EVALUATIONS	<ul style="list-style-type: none"> ▶ Conduct hatching success inventories on post-emergent nests. 	<ul style="list-style-type: none"> ▶ Conduct nesting surveys. ▶ Mark nests.
CONDUCT HATCHLING ORIENTATION INDEX (HOI) SURVEYS	<ul style="list-style-type: none"> ▶ Conducting HOI surveys. 	<ul style="list-style-type: none"> ▶ Conduct any other activity unless specifically authorized on permit.
CONDUCT NECROPSIES	<ul style="list-style-type: none"> ▶ Conducting necropsies on stranded turtles found dead or turtles that die while in captivity. 	<ul style="list-style-type: none"> ▶ Use the carcass or any parts, thereof, for any purpose not specifically listed on the permit.
CONDUCT NESTING SURVEYS	<ul style="list-style-type: none"> ▶ Nesting surveys. ▶ Marking nests. ▶ Hatching success inventories. ▶ Rescue and release hatchlings. 	<ul style="list-style-type: none"> ▶ Relocate nests. ▶ Screen nests with self-releasing ore restraining screens/cages. ▶ Use a hatchery. ▶ Conduct night public hatchling releases.
CONDUCT NIGHT PUBLIC HATCHLING RELEASES	<ul style="list-style-type: none"> ▶ To conduct night public hatchling releases. 	<ul style="list-style-type: none"> ▶ Hold hatchlings for extended time to facilitate public release. ▶ Hold hatchlings in water prior to release. ▶ Conduct nesting surveys. ▶ Relocate nests. ▶ Protect nests with self-releasing or restraining cages or screens. ▶ Use a hatchery. ▶ Excavate a nest 70 (cc) or 80 days (dc) or 72 hours after first sign of emergence, which ever comes first. ▶ Use lights to lead hatchlings to the water.
CONDUCT PUBLIC TURTLE WATCHES	<ul style="list-style-type: none"> ▶ To conduct public awareness turtle watches. 	<ul style="list-style-type: none"> ▶ Conduct public awareness turtle watches with any species other than a loggerhead. ▶ Conduct more than 5 watches per week.
CONDUCT STRANDING/SALVAGE ACTIVITIES	<ul style="list-style-type: none"> ▶ Conducting stranding and salvage activities. 	<ul style="list-style-type: none"> ▶ Transfer or transport specimens (dead or live) into or outside Florida.
HOLD LOGGERHEADS FOR EDUCATIONAL DISPLAY	<ul style="list-style-type: none"> ▶ Displaying loggerhead turtles. 	<ul style="list-style-type: none"> ▶ Display rehabilitating loggerheads turtles whose health would be compromised by the display. ▶ Display any other species [except loggerheads] solely for educational display.
HOLD NON-RELEASABLE TURTLES	<ul style="list-style-type: none"> ▶ Holding any species of marine turtle of unknown origin or whose origin does not genetically match populations found in Florida waters. ▶ Holding any species of marine turtle with a disability that would preclude it from surviving in the wild. 	<ul style="list-style-type: none"> ▶ Hold any releasable marine turtle.
HOLD TURTLES FOR REHABILITATION	<ul style="list-style-type: none"> ▶ Holding sick/injured turtles for rehabilitation. 	<ul style="list-style-type: none"> ▶ Hold turtles for educational display. ▶ Hold non-releasable turtles.

Table D-1 (Page 2). Authorized Activities.

AUTHORIZED ACTIVITY	INCLUDES:	NOT AUTHORIZED TO (UNLESS OTHERWISE STATED ON PERMIT):
MAINTAIN AND DISPLAY PRESERVED SPECIMENS	<ul style="list-style-type: none"> ▶ Maintaining and displaying preserved specimens for education and/or research ▶ To transport or transfer preserved specimens within Florida. 	<ul style="list-style-type: none"> ▶ Transport or transfer preserved specimens into or out of Florida. ▶ Collect new specimens without consulting with FWC staff first.
MARK AND EVALUATE NESTS	<ul style="list-style-type: none"> ▶ Marking nests for hatching success inventories. 	<ul style="list-style-type: none"> ▶ Conduct nesting surveys. ▶ Relocate nests.
RELOCATE NESTS FOR CONSERVATION PURPOSES	<ul style="list-style-type: none"> ▶ To relocate nests. ▶ To mark nests. 	<ul style="list-style-type: none"> ▶ Conduct nesting surveys. ▶ Protect nests with self-releasing or restraining cages. ▶ Use a hatchery. ▶ Relocate a clutch at anytime after 9:00 AM the morning following deposition. ▶ Use probes (other than fingers) to locate clutch.
RESCUE AND RELEASE HATCHLINGS	<ul style="list-style-type: none"> ▶ Collecting and releasing hatchlings found on the beach. ▶ Holding hatchlings until release occurs. 	<ul style="list-style-type: none"> ▶ Conduct nighttime hatchling releases. ▶ Collect hatchlings that are still in the nest.
SCREEN NESTS WITH RESTRAINING CAGES	<ul style="list-style-type: none"> ▶ Screening nests with restraining cages. ▶ Marking nests ▶ Hatching success inventories 	<ul style="list-style-type: none"> ▶ Conduct nesting surveys. ▶ Relocate nests. ▶ Use a hatchery. ▶ Use any caging material with a mesh size smaller than 2” by 4” unless authorized to protect nests with restraining cages or if there is an alternative escape area. ▶ Use probes (other than fingers) to locate clutch.
SCREEN NESTS WITH SELF-RELEASING SCREENS/CAGES	<ul style="list-style-type: none"> ▶ Protecting nests with self-releasing screen/cage. ▶ Marking nests. ▶ Hatching success inventories. 	<ul style="list-style-type: none"> ▶ Conduct nesting surveys. ▶ Relocate nests. ▶ Screen nests with restraining cage. ▶ Use a hatchery. ▶ Use any screening material with a mesh size smaller than 2” X 4”. ▶ Use probes (other than fingers) to locate clutches.
TAG TURTLES USING EXTERNAL FLIPPER TAGS	<ul style="list-style-type: none"> ▶ Flipper tagging turtles. 	<ul style="list-style-type: none"> ▶ Hold turtles for any reason other than that specified on the permit (i.e., approved research, rehabilitation, or education). ▶ PIT tag turtles.
TAG TURTLES USING PIT TAGS	<ul style="list-style-type: none"> ▶ PIT tagging turtles. 	<ul style="list-style-type: none"> ▶ Hold turtles for any reason other than that specified on the permit (i.e., approved research, rehabilitation, or education). ▶ Flipper tag turtles.
USE [LIVE] TURTLES IN EDUCATIONAL PRESENTATIONS	<ul style="list-style-type: none"> ▶ Using live turtles in educational presentations (e.g., away from the approved facility). ▶ Holding loggerheads for educational display at an approved facility. 	<ul style="list-style-type: none"> ▶ Transport or transfer turtles into or out of Florida.

Table D-2. Reporting requirements.

ACTIVITY	REPORTING REQUIREMENTS*
<p>Conduct nesting surveys for conservation purposes – includes:</p> <ul style="list-style-type: none"> ▶ Marking nests ▶ Examine hatch success ▶ Fire ant control ▶ Hatching rescue and release 	<p>An annual marine turtle nesting summary report is due by November 30th of each year (forms will be mailed out each year prior to the beginning of the season). Upon request, field data sheets may also be required. Annual reports must include information on conservation activities conducted in association with the nest surveys (i.e., number of nests: marked, relocated, caged/screened, evaluated for hatch success, and measures taken to control fire ants, including nest relocation and/or early excavation). A disorientation form should be submitted for each disorientation event observed.</p>
<p>Conduct nesting surveys for DEP permitted coastal construction projects – includes (same as above)</p>	
<p>Conduct nesting surveys for INBS</p>	<p>Weekly reports submitted to the Sebastian Field Office.</p>
<p>Examine hatch success (nest inventory)</p>	<p>Annual report (as part of nesting survey report)</p>
<p>Screen nests with restraining or self-releasing screen/cage</p>	<p>Annual nesting summaries must include the total number of nests screened and/or caged and the reasons for screening/caging.</p>
<p>Relocate nests</p>	<p>Annual nesting summaries must include the number of nests relocated and the reason(s) for relocation.</p>
<p>Conduct nighttime public hatchling releases</p>	<p>The number of public hatchling releases held each year must be submitted with the annual renewal application.</p>
<p>Tag and release turtles</p>	<p>Copies of tagging forms must be submitted for each turtle tagged.</p>
<p>Conduct research projects</p>	<p>Annual summary reports are required for each research project listed on the permit. A final report is required within 90 days of completion of the project (submit 3 copies of the final report).</p>
<p>Conduct stranding/salvage activities</p>	<p>A STSSN report must be submitted for each animal stranded live or dead. The report must be faxed to (561-743-6228) or called in to stranding staff within 48 hours of the event (you may page stranding staff if the call is long distance).</p>
<p>Conduct necropsies</p>	<p>Necropsy reports must be submitted for each turtle that dies in captivity and for all dead strandings necropsied.</p>
<p>Maintain and display preserved specimens</p>	<p>No regular reporting required but, upon request, a written inventory of all preserved specimens must be provided to FWC.</p>
<p>Conduct public awareness turtle watches</p>	<p>A schedule of planned watches must be submitted before the first watch of the season and by no later than May 25th. In addition, a summary of all watches actually conducted must be submitted with the annual renewal application.</p>
<p>Hold live turtles – including:</p> <ul style="list-style-type: none"> ▶ Holding loggerheads for education ▶ Holding marine turtles for rehabilitation ▶ Holding non-releasable marine turtles ▶ Holding marine turtles for research 	<p>Quarterly reports must be submitted for all marine turtles held in captivity. Quarterly reports are due on the 15th of April, July, October and January. In addition, an annual (calendar year) report is required that includes: the SID number, tag numbers (if tagged), species, sex (if known), acquisition date, purpose of acquisition, disposition date, and measurements at disposition. Annual facility reports are due by January 31st for the previous year's activities. For researchers, the annual report should be incorporated into the annual research project report and is due by December 31st for activities occurring during that year. Turtles transferred from one in-state facility to another must be accompanied by a transfer form.</p>
<p>Use [live] turtles in educational presentations</p>	<p>The use of marine turtles in education presentations (offsite of facility) must be submitted each year with the annual renewal application.</p>
<p>Conduct educational snorkel/dive programs</p>	<p>Immediately report to FWC of injury to any person resulting from participation in a dive/snorkel program.</p>

*Copies of all the FWC forms listed above (except nesting summary forms which are mailed out at the beginning of each nesting season) are located in Appendix A.

Table D-3. Why’s and how’s of nest protection and marking (complete details of techniques and requirements are located in Section 2).

NEED (Why)	NESTS CHOSEN	LOCATE CLUTCH?	TECHNIQUE (How)	REQUIREMENTS
Protection from ants	Any nest that is threatened	No	Apply baits	Use only when needed
Protection from mammalian predators	Any nest that is threatened	Yes	Self-releasing screen or cage with a nest sign attached	Must be specifically permitted to screen or cage. Remove cage or screen after emergence
Protection from artificial lighting	Nests where disorientation occurs despite extensive light management	Yes	Restraining cage with nest sign attached	Must be specifically permitted to cage. Monitor cage nightly between 11 pm to 1 am and 5 am to 7 am starting on day 45 of incubation.
Protection from foot traffic	Nests in densely used footpaths	No	Three to four stakes and ribbon surrounding the nest.	Remove stakes after emergence is complete
Data collection for hatching success	All caged, screened and hatchery nests and every n th nest	Yes	Multiple stakes that pinpoint the clutch location. Back-up stakes hidden in dune are recommended	Monitor nest regularly; attempt to find every marked nest for inventory
Data collection for predation rate only	Every n th nest	No	Visible stake offset from estimated clutch location	Monitor nest regularly; attempt to find every marked nest for predation assessment

Note: Copies of the annual nesting summary forms are mailed out at the beginning of each nesting season.

Table D-4. Quick Reference for Conducting Nesting Surveys & Related Activities

ACTIVITY	PROPER METHODOLOGY
Conduct nesting surveys for conservation:	<ol style="list-style-type: none"> 1. Walk the beach along/seaward of most recent high tide line. 2. When a fresh crawl is located, identify which track is emerging from water and which is returning to water. 3. Determine what species of turtle made the crawl. 4. Determine if the crawl was a nesting or non-nesting emergence. 5. Document nest, mark nest, and/or relocate nest (only when required for conservation purposes). 6. Obliterate section of upper track (NOT NEST SITE) by sweeping feet over track or crossing over track with survey vehicle.
Identify which track is emerging from water and which track is returning to water:	<ol style="list-style-type: none"> 1. As a turtle crawls forward, sand is pushed back with each flipper stroke. 2. If one track is shorter, it is the emerging (incoming) track. 3. If the tracks overlap, the returning (outgoing) track will be on top.
Determine if the crawl was made by a loggerhead turtle:	<ol style="list-style-type: none"> 1. Alternating gait observed in tracks. 2. No tail drag mark. 3. Track width range = 70-124 cm (27.6-48.8 in) with a mean of 94 cm (37 in).
Determine if the crawl was made by a green turtle:	<ol style="list-style-type: none"> 1. Simultaneous limb movement. 2. Central tail drag mark (solid or broken line). 3. Track width range = 95-144 cm (37.4-56.7 in) with a mean of 119 cm (44.8 in).
Determine if the crawl was made by a leatherback turtle:	<ol style="list-style-type: none"> 1. Simultaneous limb movement. 2. Central tail drag mark (solid or broken line). 3. Track width range = 175-214 cm (68.9-84.3 in) with a mean of 196 cm (77.2 in). 4. Track path sometimes circles or is sinusoidal (s-shaped).
Determine if the crawl was a loggerhead turtle nest:	<ol style="list-style-type: none"> 1. Follow the emerging (incoming) track of the turtle. 2. Look for secondary body pit and/or escarpment. 3. Look for sand misted or thrown over the emerging track.
Determine if the crawl was a loggerhead turtle non-nesting emergence:	<ol style="list-style-type: none"> 1. Follow the emerging (incoming) track of the turtle. 2. Look for very little or no sand disturbed other than tracks. 3. Look for a back stop with sand pushed back (not thrown) over emerging tracks, typically between two mounds of sand piled by the front flippers during the construction of the primary body pit. 4. Look for sand disturbed from digging efforts, but with the crawl exiting the disturbed area and continuing toward the dune before turning toward the ocean. 5. Look for sand disturbed from digging efforts, but with a smooth-walled or abandoned/open egg chamber.

Table D-4. (Page 2) Quick Reference for Conducting Nesting Surveys & Related Activities

PROPER METHODOLOGY	
<p>Determine if the crawl was a green turtle nest:</p>	<ol style="list-style-type: none"> Follow the emerging (incoming) track of the turtle. Look for sand thrown into a mound covering more than 78 in of the emerging track. Look for a deep (20-50 cm or 7.8-19.7 in) secondary body pit with an escarpment.
<p>Determine if the crawl was a green turtle non-nesting emergence:</p>	<ol style="list-style-type: none"> Follow the emerging (incoming) track of the turtle. Look for very little or no sand disturbed other than the tracks. Look for a body pit smaller than 20-50 cm (7.8-19.7 in) with little or no escarpment.
<p>Determine if the crawl was a leatherback turtle nest:</p>	<ol style="list-style-type: none"> Crawl covers >4 square meters with sand thrown in multiple directions.
<p>Determine if the crawl was a leatherback turtle non-nesting emergence:</p>	<ol style="list-style-type: none"> Crawl covers <4 square meters and minimal thrown sand is observed.
<p>Approximating the clutch location the morning after deposition:</p>	<ol style="list-style-type: none"> Follow the emerging (incoming) track of the turtle. If a loggerhead nest (see previous page), often the clutch can be approximated ~2' into the disturbed area. If a green nest (see previous page), often the clutch can be approximated ~3' back from the escarpment created by covering activities. If a leatherback nest (see above), often the clutch can be approximated ~4.5' back from the escarpment created by covering activities.
<p>Precisely locating the clutch location the morning after deposition:</p>	<ol style="list-style-type: none"> Follow the emerging (incoming) track of the turtle. Gently & systematically dig by hand, focusing efforts in the center of the mound of sand created by turtle. Probe with fingers only – DO NOT USE SHOVELS OR ANY OTHER TOOLS TO DIG OR PROBE. Once the top of the clutch is located, re-bury it with moist sand and gently pat sand surface with hand. Replace dry sand over the clutch to the depth present before you began, placing a temporary marker over (but not into) the clutch site.
<p>Marking the nest site to determine hatchling success:</p>	<ol style="list-style-type: none"> Either approximately or precisely locate the clutch location of a fresh nest. Measure and record the exact distance from the approximate or precise clutch location to two separate marking stakes on the dune that are aligned so that they are directly oriented toward the location of the clutch. An additional stake may be driven deeply & hidden from view a measured distance landward (i.e. not on the nesting beach) of the first two stakes. Nest-identifying information (including species & date of deposition) should be recorded on at least one of the stakes.

Table D-4. (Page 3) Quick Reference for Conducting Nesting Surveys & Related Activities

ACTIVITY	PROPER METHODOLOGY
<p>Marking the nest site to protect clutch from hazardous activities (i.e. beach cleaning, vehicular traffic, or construction):</p>	<ol style="list-style-type: none"> 1. Visually inspect the site to determine if a nest exists. If you are unsure if eggs were deposited, mark the area as a nest. 2. An area of at least 3' radius centered on the approximate clutch location (or the entire disturbed area where digging has occurred, if greater than 3') should be delineated with stakes. Surveyor's ribbon and nest signs may be placed on stakes, as well. 3. For construction permits, approximate the location of the clutch and use stakes to mark off an area of at least 3' radius centered on the approximate clutch location. Be sure to refer to the individual project monitoring requirements to ensure that the proper amount of area has been staked off. 4. An additional stake should be placed a measured distance from the approximate clutch location at the base of the dune or seawall. 5. Nest-identifying information should be recorded on at least one of the stakes.
<p>Protect nests with self-releasing screen/cage:</p>	<ol style="list-style-type: none"> 1. The methodology described to "Protect nests with restraining cage" or the methodology described below may be used for this activity. 2. Find the precise location of the egg chamber (see previous page) and place a temporary marker in the sand above the clutch (DO NOT INSERT MARKER INTO THE EGG CHAMBER). Level the sand. 3. Using a 4' x 4' cage made of no smaller than 2" high x 4" long mesh welded wire, center the cage over the egg chamber and trace the edges of the cage in the sand. 4. Remove the cage or screen, then by hand remove ~2" of surface sand from the 4' x 4' square. 5. Remove the temporary marker and replace the cage or screen over the clutch, making sure that 4" openings of mesh are parallel to sand. 6. Secure the four corners of the screen/cage using stakes driven in at an angle away from the egg chamber. 7. Replace the removed sand on top of the screen.
<p>Protect nests with restraining cage:</p>	<ol style="list-style-type: none"> 1. Find the precise location of the egg chamber (see previous page) and place a temporary marker in the sand above the clutch (DO NOT INSERT MARKER INTO THE EGG CHAMBER). Level the sand. 2. Using a cage with mesh smaller than 2" x 4", center the cage over the egg chamber and trace the edges of the cage in the sand. 3. Remove the cage and temporary marker. 4. Dig a 1' deep trench along the tracing of the edges of the cage. 5. Place the cage into the trench and fill the trench with sand, making sure that the sand over the egg chamber and around the cage is at the original level. 6. Cage must be checked twice nightly (once between 11 p.m. and 1 a.m., and once between 5 a.m. and 7 a.m.), starting 45 days after the eggs were deposited. 7. Hatchlings found within the cage at night should be immediately released at an appropriate site and allowed to crawl to the water. Hatchlings found within the cage during daytime hours should be released according to guidelines set forth on page 2-16.

Table D-4. (Page 4) Quick Reference for Conducting Nesting Surveys & Related Activities

ACTIVITY	PROPER METHODOLOGY
Relocating nests:	<ol style="list-style-type: none"> 1. Find the precise location of the egg chamber (see previous page) by digging by hand and probing with fingers only (DO NOT USE SHOVELS OR ANY OTHER TOOLS TO DIG OR PROBE). 2. After locating the egg chamber, place a 2”- 3” layer of moist sand from around the top eggs into the bottom of a rigid container. 3. Individual eggs should be gently lifted from the chamber without rotating the eggs in any direction and avoid abrupt movements. 4. When all eggs are in the container, cover them with a layer of moist sand. Measure the depth of the nest cavity. 5. Determine a suitable nearby location on the beach, above high tide level and not in dense vegetation. 6. Dig, by hand, a new nest cavity (of the same depth as the original egg chamber) with a spherical bottom and a neck that is narrower than the bottom by 2” - 4”. 7. Place the eggs into the new chamber without rotating the eggs in any direction and avoiding abrupt movements. 8. Once all eggs have been transferred into the new egg chamber, cover them with the moist sand that was excavated from the original egg cavity. Place additional moist sand above the eggs to the level of surrounding moist sand and pat gently with hand. Replace dry sand over the area to the depth present before you began. 9. ALL NESTS MUST BE TRANSFERRED TO THE NEW LOCATION BY 9 A.M. THE MORNING FOLLOWING DEPOSITION ONLY.
Conducting nest inventory:	<ol style="list-style-type: none"> 1. Nests may be evaluated 3 days after the first hatching emergence or 70 days after nest deposition (80 days in the case of a leatherback) or if the nest was frequently inundated or overwashed, whichever arrives first. 2. Dig into the nest chamber by hand (DO NOT USE SHOVELS OR ANY OTHER TOOLS TO DIG OR PROBE) until eggs or eggshells are reached. If more than one live hatching is encountered before reaching any eggs or eggshells, cover the egg chamber with moist sand. Wait at least 24 hours before attempting to excavate again. 3. Remove the contents of the nest, piling them on sand or in a tray. 4. Separate the contents into: hatched eggs (empty eggshells > 50% complete, disregard smaller pieces), live hatchlings, dead hatchlings, pipped eggs with live hatchlings, pipped eggs with dead hatchlings, and unhatched eggs. 5. Determine number of hatched eggs by counting eggshells (an eggshell >50% complete = 1 egg, disregard smaller pieces) and subtracting the number live and dead hatchlings from the total number of empty eggshells. 6. Determine and separately record the number of pipped eggs with live hatchlings, pipped eggs with dead hatchlings, and unhatched eggs. 7. Determine the total number of eggs present by adding together the hatched eggs, all pipped eggs, and the unhatched eggs.

Table D-4. (Page 5) Quick Reference for Conducting Nesting Surveys & Related Activities

ACTIVITY	PROPER METHODOLOGY
Hatchling rescue and release:	<ol style="list-style-type: none"> 1. Hatchlings found during darkness should be released immediately. 2. If <5 hatchlings are found disoriented or at the bottom of inventoried nests during daylight hours, they may be released on the beach immediately (no later than 9 a.m.). 3. Hatchlings that must be held until the following night should be placed in rigid containers lined with damp sand, and loosely covered with a lid or towel to provide a dark environment. 4. When releasing hatchlings, place them on the beach and allow them to crawl to the water on their own. DO NOT USE ARTIFICIAL LIGHT SOURCES DURING HATCHLING RELEASES. 5. If a hatchling requires assistance in reaching the water, it may be moved closer to the water's edge or placed in the shallow water and allowed to swim off on its own. 6. If a hatchling is weak or injured and needs to be held for more than 2-3 days, contact FWC to arrange to transfer it to an authorized rehabilitation facility.